

BGV INTEGRATION

BGV INTEGRATION

3rd February 2014

BGV INTEGRATION

Some infos :

- Single RPT layout
- Frontend cables
- Bias distribution and cables
- Temperature readout and cables
- Low voltage distribution and cables
- RPT crate design
- LV patch panel
- NTC and Bias patch panel
- ...

BGV INTEGRATION

BGV single RPT layout (8x)

RPT board :
320 x 320mm

RPT fanout card :
320 x 70mm max

FE support card :
250 x 70mm max

RPT cables

FE cables

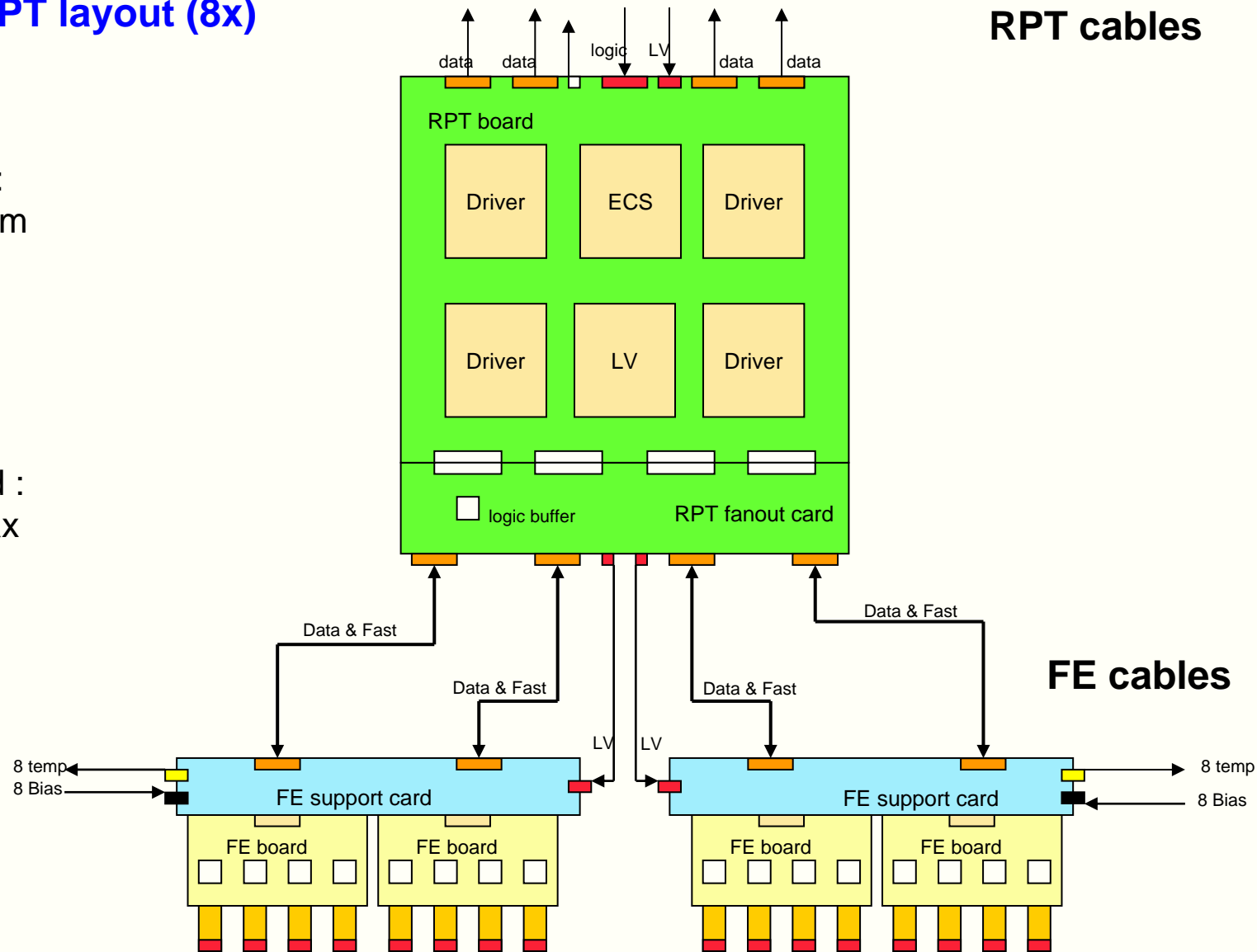

BGV INTEGRATION

FE cables (FE card to RPT fanout card):

Data & Fast cable:

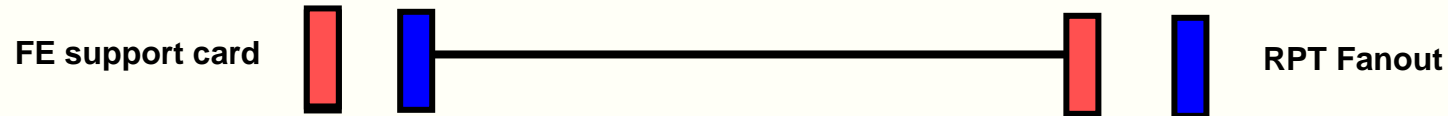

Card connector:

- RPT Fanout card : 50P Dsub female
- FE card : 50P Dsub male

Cable connector :

- RPT side : 50P Dsub male crimp
- FE card side. 50P Dsub female crimp

Cable : Round shielded twisted pairs for IDC connector

- 25 pairs AWG 28
- ext. diam : 10 mm
- Impedance : 100 ohm
- max length : 4 m
- SCEM 04.21.51.550.4 MA50

- quantity : (4 per RPT card) total 32 cables

BGV INTEGRATION

FE cables (FE card to RPT fanout card):

LV cable:

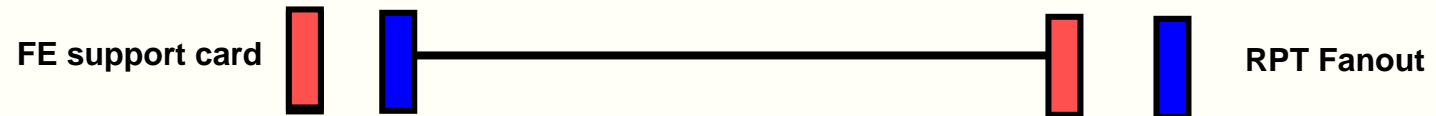

Card connector:

- RPT Fanout card : 15P Dsub female
- FE card : 15P Dsub male

Cable connector :

- RPT side : 15P Dsub male solder/crimp
- FE card side. 15P Dsub female solder/crimp

Cable : SABIX D315 FRNC ref : 63151250 (51.50.43)

- Halogen free, no flame propagation, self extinguishing
- Round shielded
- 12 x 0,5 mm²
- ext. diam : 9 mm
- Vmax : 500V
- max length : 4 m
- Vdrop max : 180mV

- quantity : (2 per FE support card) 16 cables

BGV INTEGRATION

Cable specs :

HALOGEN-FREE CABLES

with extended temperature range

SABIX® D 315 FRNC Flexible data cable with improved fire performance and overall copper screen



Marking for SABIX D 315 FRNC 63150750:
SAB BRÜCKSKES · D-VIERSEN · SABIX D 315 FRNC 7 x 0,5 mm² CE

Construction:

Conductor:	bare copper strands acc. to DIN VDE 0812
Insulation:	SABIX® 338
Colour code:	with reference to DIN 47100
Stranding:	in layers
Wrapping:	PETP foil
Screen:	tinned copper braiding
Sheath material:	SABIX® FRNC
Sheath colour:	grey (RAL 7032)

Outstanding features:

- halogen-free
- good EMC characteristics*
- no flame propagation
- flame retardant and self-extinguishing

* Copper braiding should be connected circularly to optimize the EMC characteristics

Technical data:

Peak operating voltage:	< 0.25 mm² = max. 350 V ≥ 0.25 mm² = max. 500 V
Testing voltage:	< 0.25 mm² = 800 V ≥ 0.25 mm² = 1200 V
Min. bending radius	
<i>fixed laying:</i>	5 x d
<i>flexible application:</i>	10 x d
Temperature range	
<i>fixed laying:</i>	-40/+85 °C
<i>flexible application:</i>	-30/+85 °C
Halogen-free:	acc. to DIN VDE 0472 part 815 and IEC 60754-1
Fire performance:	no flame propagation acc. to IEC 60332 + EN 60332 cat. C resp. D (see page N/20) flame retardant and self-extinguishing acc. to IEC 60332-1-2 + EN 60332-1-2
Corrosiveness of conflagration gases:	in compliance with IEC 60754-2 and EN 50267-2-2 + VDE 0482 part 267-2-2 - no development of corrosive conflagration gases
Smoke density:	acc. to IEC 61034 + EN 61034
Flexibility:	good
Absence of harmful substances:	acc. to RoHS directive of the European Union see page N/14

BGV INTEGRATION

BGV bias distribution :

Based on CAEN A1539 module :

- 32 channels
- 100V / 10mA
- supplies 4 SIPM per channel

Channels grouped by 4 on patch via DIP switch

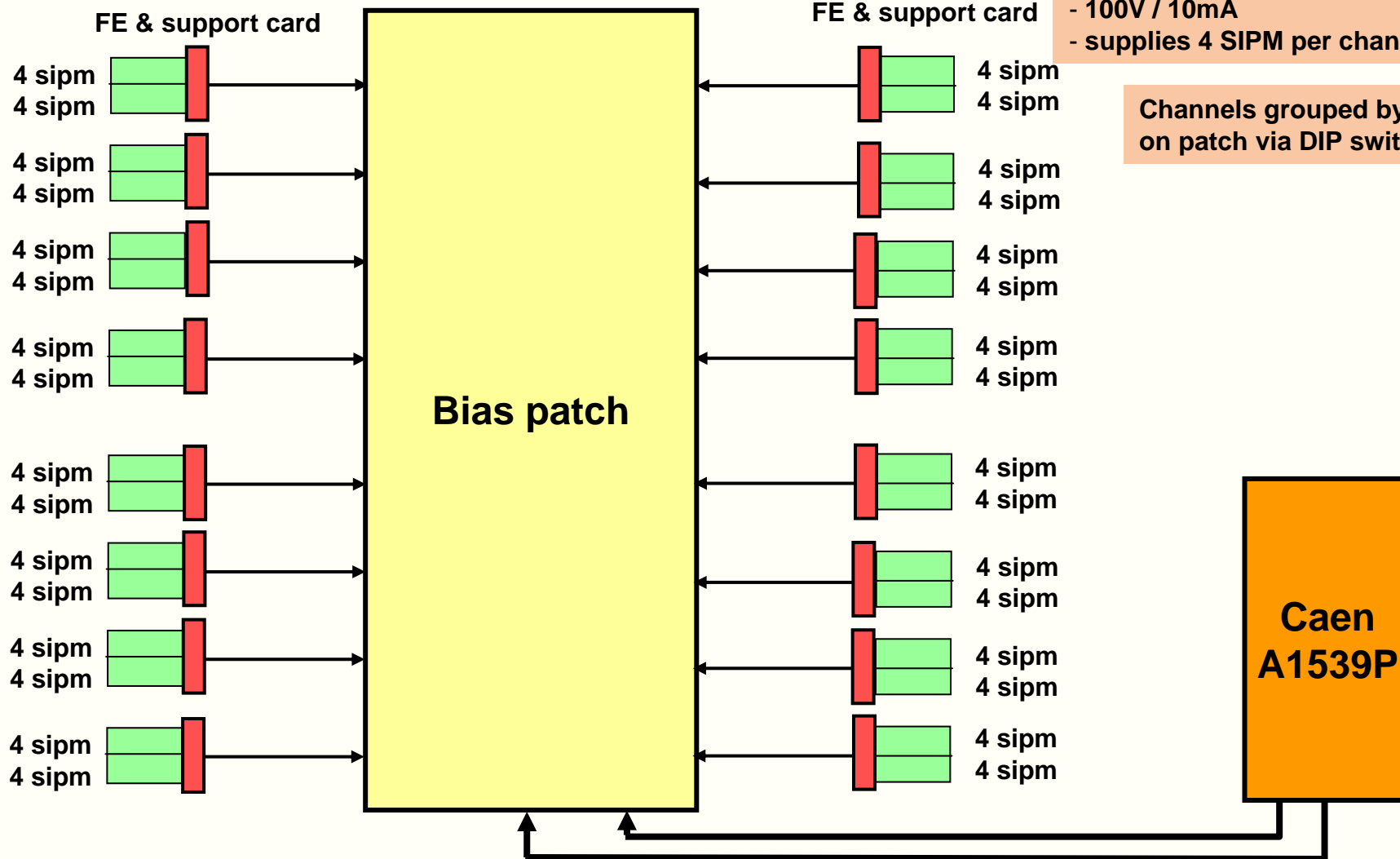

Bias patch board under design

31st February 2014

Raymond.Frei@epfl.ch

BGV INTEGRATION

Bias cable (FE support card to patch):

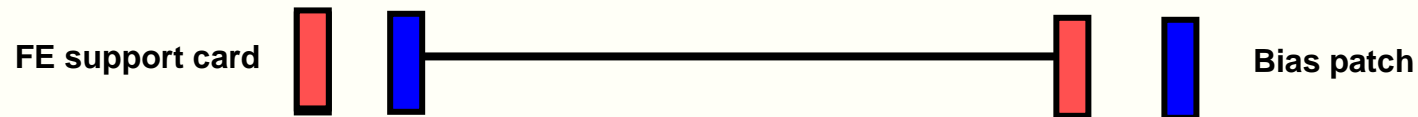

Card connector:

- FE support card : 9P Dsub male
- Bias patch : 9P Dsub female

Cable connector :

- FE support card side : 9P Dsub female solder/crimp
- Bias patch side: 9P Dsub male solder/crimp

Cable : SABIX D315 FRNC ref : 63151025 (51.50.18)

- Halogen free, no flame propagation, self extinguishing
- Round shielded
- 10 x 0,25 mm²
- Vxt. diam : 6,6 mm
- Vmax : 500V
- max length : 5 m

- quantity : (1 per FE support card) 16 cables

BGV INTEGRATION

Bias cable (from patch to A1539 CAEN module):

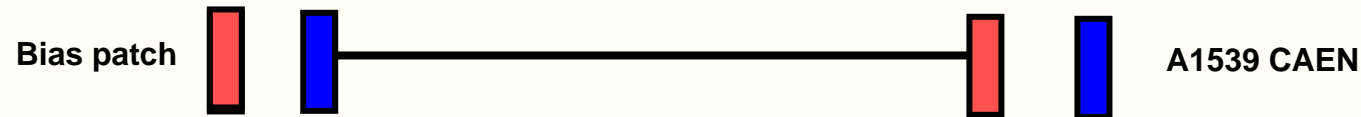

Card connector:

- Bias patch : 25P Dsub male
- A1539 module : 25P Dsub female

Cable connector :

- Bias patch side : 25P Dsub female solder/crimp
- A1539 module side: 25P Dsub male solder/crimp

Cable : SABIX D315 FRNC ref : 63152125 (51.50.23)

- Halogen free, no flame propagation, self extinguishing
- Round shielded
- 21 x 0,25 mm²
- Ext. diam : 8,8 mm
- Vmax : 500V
- max length : 60m (+/- 7m)

- quantity : 2 cables

BGV INTEGRATION

BGV temperature readout :

For 1/2 BGV system

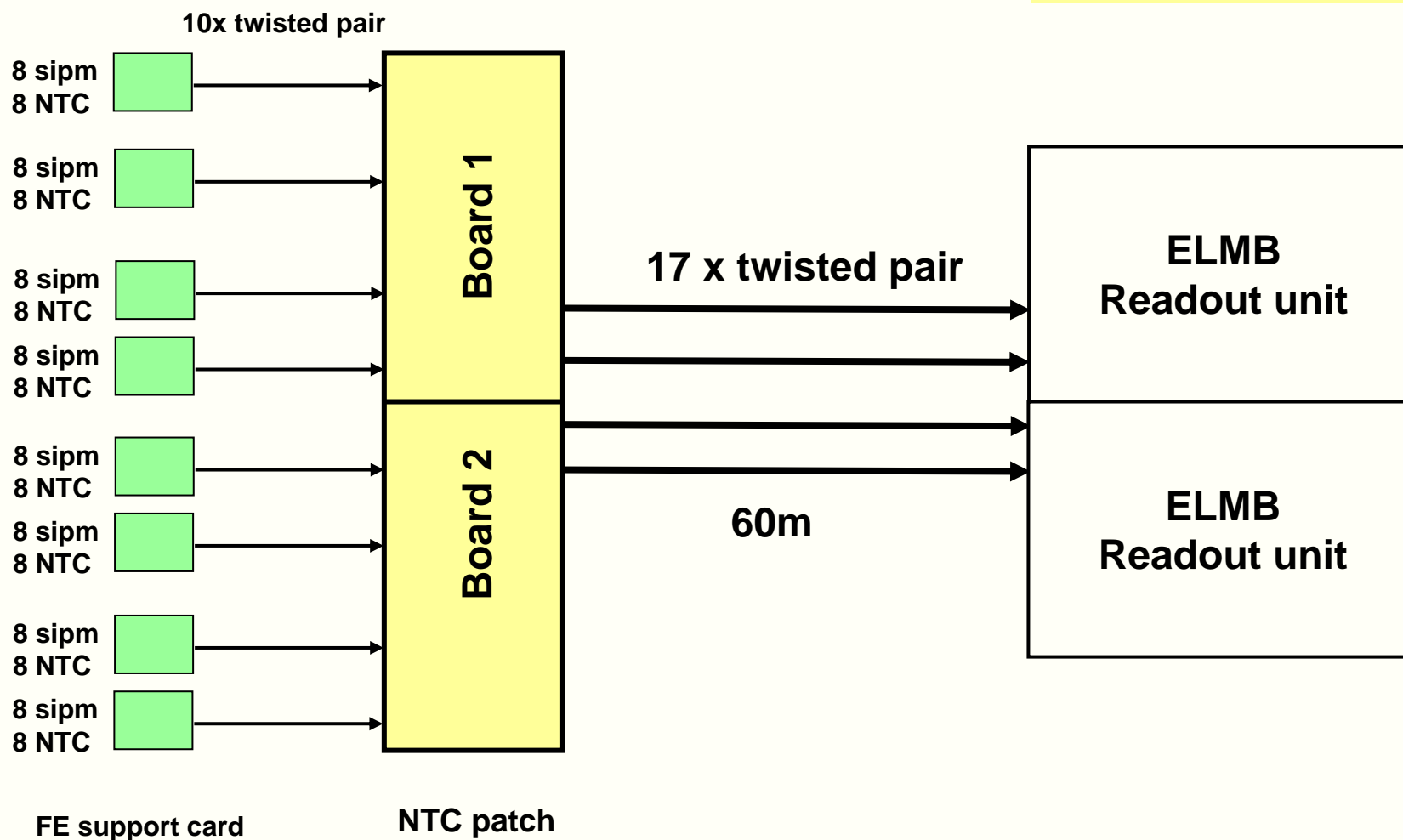

BGV INTEGRATION

Temperature cable (from FE support card to NTC patch) :

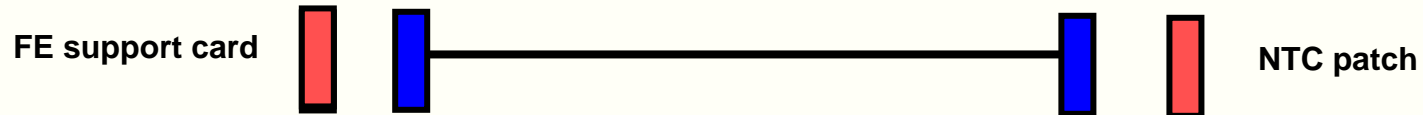

Card connector:

- FE support card : 20P DIN41651 vertical male
- NTC patch : 20P DIN41651 vertical male

Cable connector :

- FE support card side : 20P DIN41651 female crimp
- NTC patch side: 20P DIN41651 female crimp

Cable : Twisted pair flat ribbon cable for IDC 1,27

- 10 x 2 pairs
- SCEM 04.21.22.420.4 (3M ref:2100/20)

- max length : 5m

- quantity : 16 cables

BGV INTEGRATION

Temperature cable (from NTC patch to ELMB) :

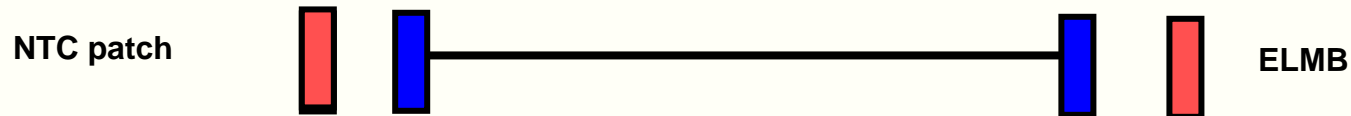

Card connector:

- NTC patch : 34P DIN41651 vertical male
- ELMB : 34P DIN41651 vertical male

Cable connector :

- NTC patch side : 34P DIN41651 female crimp
- ELMB side: 34P DIN41651 female

Cable : Loose twisted pair flat round cable for IDC 1,27

- 17 x 2 pairs
- ext. Diameter : 10,8 mm
- SCEM 04.21.22.734.9 (3M ref:79985 – 17PM540)
- max length : 60m (+/- 7m)
- quantity : 4 cables

BGV INTEGRATION

NTC patch :

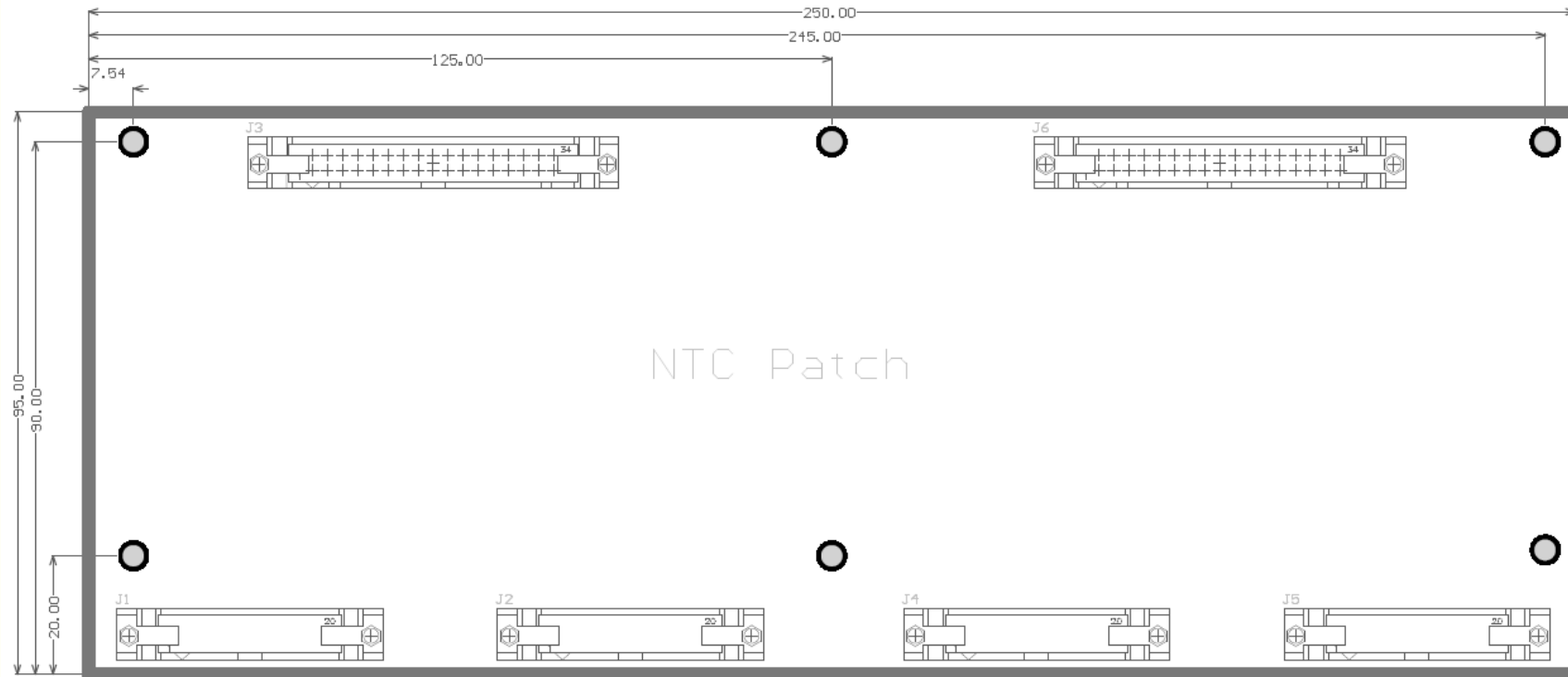

- NTC board : 250 x 95 mm
- Need 4 boards for NTC complete patch
- NTC patch could be split into 2 x 2 boards

BGV INTEGRATION

BGV low voltage distribution (RPT cables) :

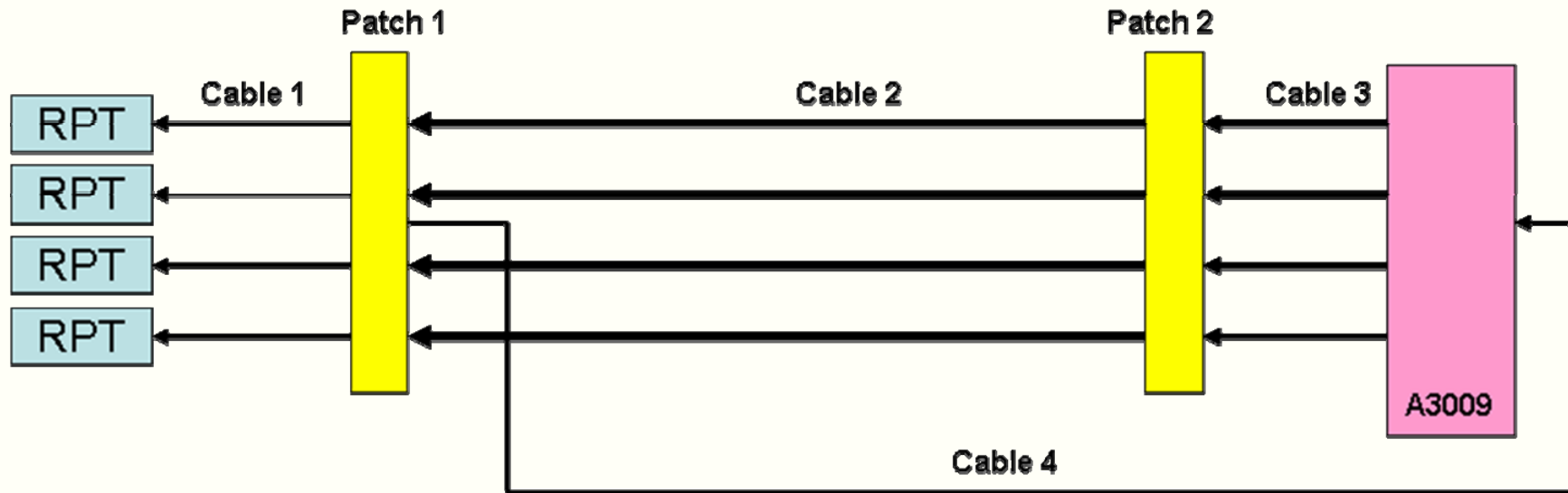
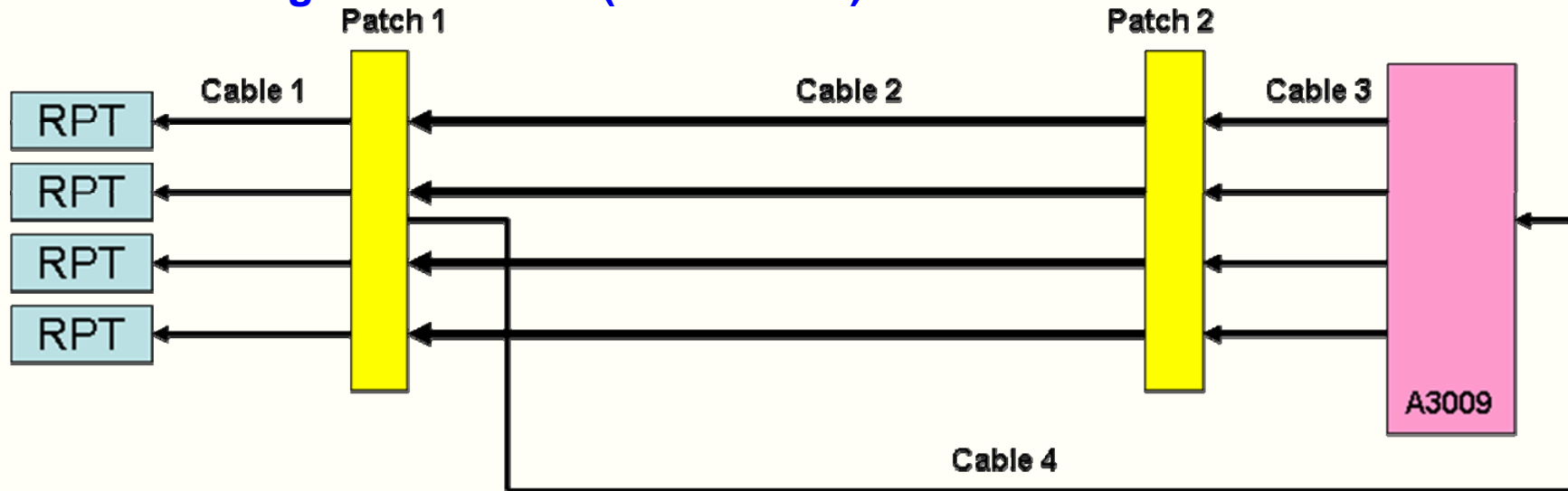

BGV INTEGRATION

BGV low voltage distribution (RPT cables) :

Cable 1 : between RPT board and patch 1 in tunnel.

Max. length : 7m
Type : NE26 SCEM : 04.21.52.140.4
13x2 shielded twisted pair 0,5mm²
External diameter 16,5 mm

Number of cables needed : 8

Connection :

- On RPT side : DSUB 25 pin female
- On patch side : screw terminal

Cable 2 : between patch 1 in tunnel and patch 2 on LV rack.

Max. length : 60m
Type : NG28 SCEM : 04.21.52.228.7
14x2 shielded twisted pair 1mm²
External diameter 20mm

Number of cable needed : 8

Connection :

- Screw terminal on both side
- Shield cable clamped to earth on both side

Cable 3 : from patch 2 in LV rack to LV supply module

Max. length : 7 m
Type : MFX8L SCEM : 04.21.01.608.8
Signal 8 x 0, 75mm²
External diameter 11,2 mm

Number of cables needed: 8\$

Connection :

- Screw terminal on patch 2
- Connector on LV module side if module needs connector, OR, screw terminal on LV module

Cable 4 : sense line cable from patch 1 to LV module

Max. length : 60m
Type : MCA26 SCEM : 04.21.48.326.7
13 x 2 shielded twisted pair 0,22 mm²
External diameter : 11,4 mm

Number of cable needed : 2

Connection :

- Screw terminal on patch 1 side
- AMP connectors on LV module side

BGV INTEGRATION

BGV LV patch : 440 x 50 x 30mm

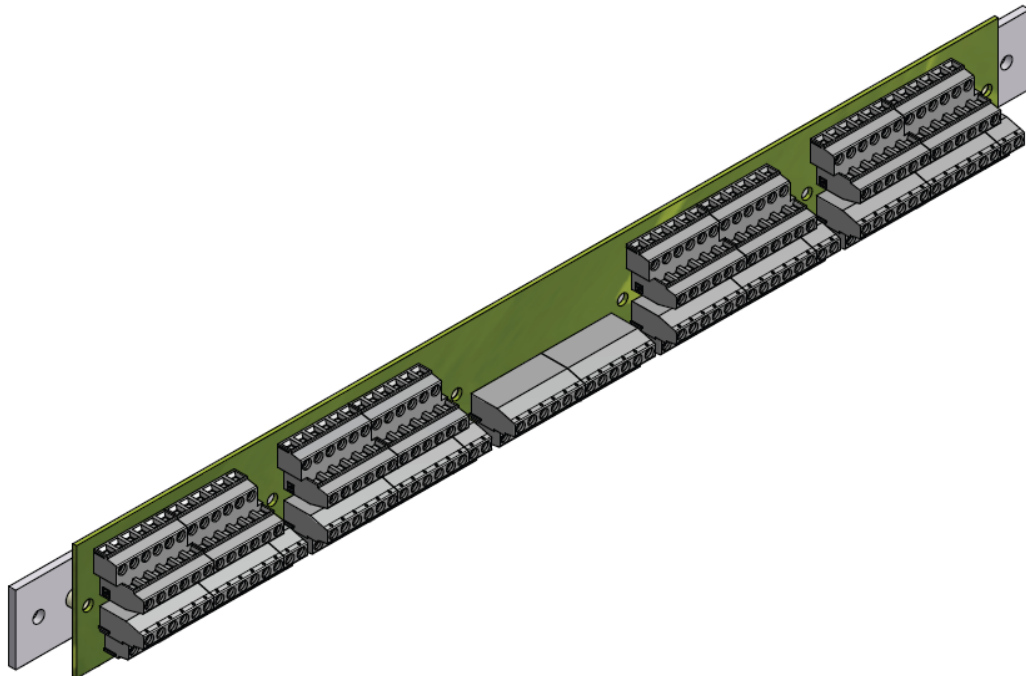
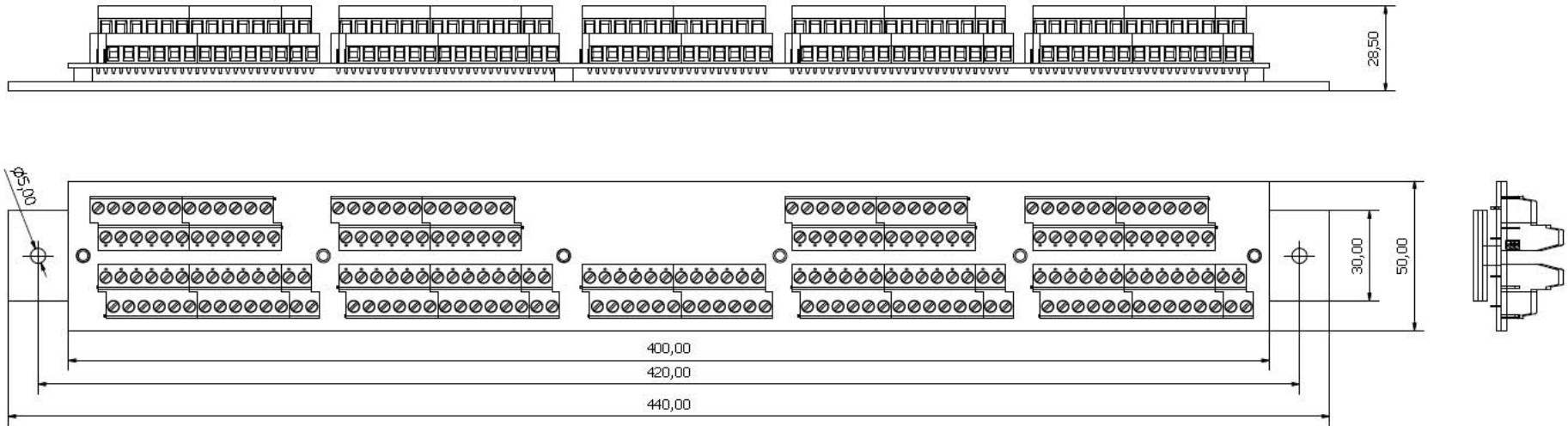

- 2 pcs on detector side
- +1 for spare
- 2 pcs on LV supply side
- +1 for spare
- board produced

BGV INTEGRATION

BGV LV system : based on A3009B CAEN

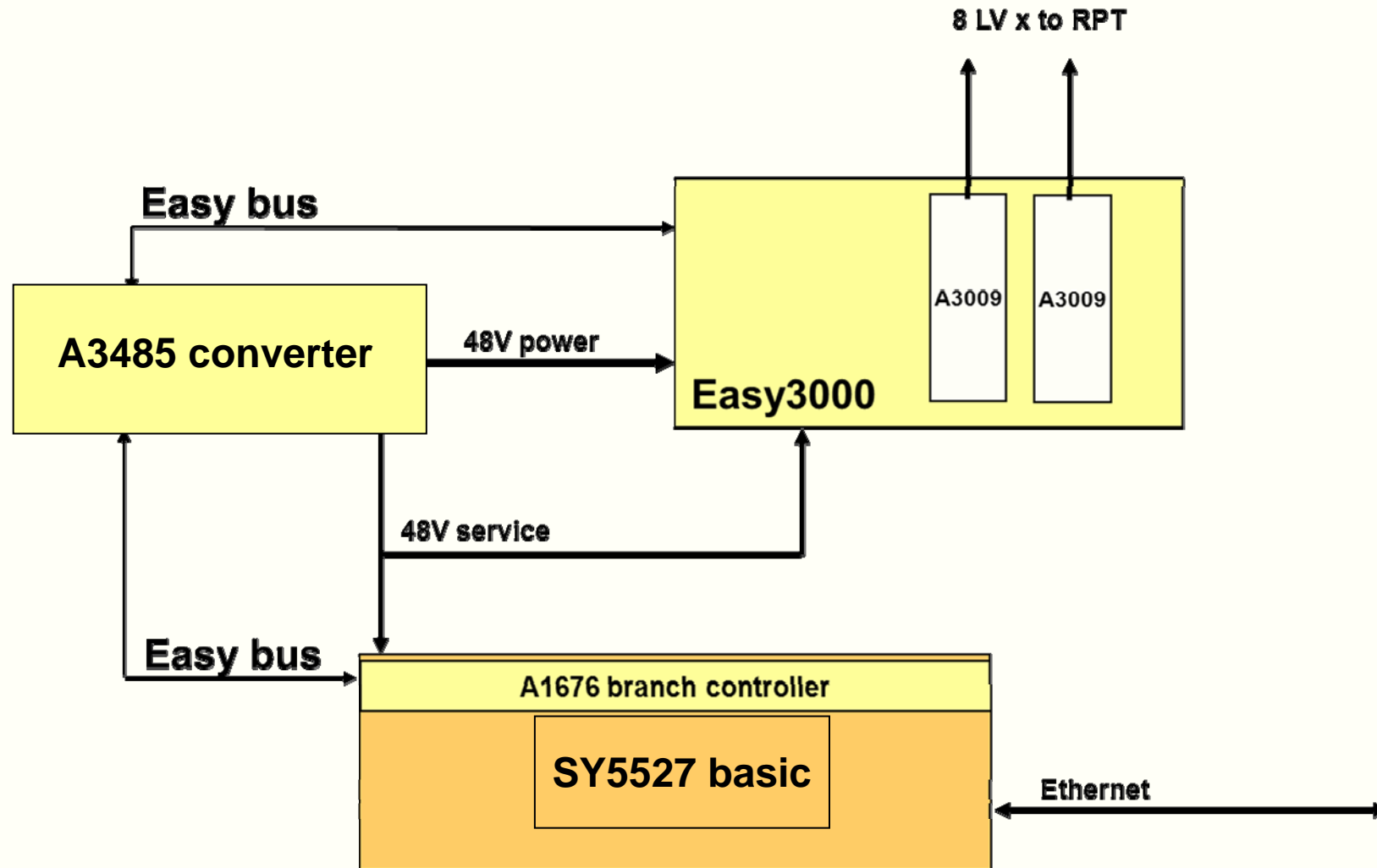

BGV INTEGRATION

BGV LV CAEN sytem :

quantity	Item	description	remark
3	A3009B	12ch 8V 8A LV module bolt connector	2 needed + 1 spare
1	EASY3000B	EASY crate bolt connector	
1	EASY3000F	Easy fan unit	
1	A3485	3phase 400V 2x 2,5kW converter	provides service and power 48V
2	A1676	Branch controller	1 needed + 1 spare
1	A5527	5527 basic mainframe	
1	A4528	5527 CPU basic module	
1	A4533	LCD display unit	
1	A4531	Primary supply 600W	
1	SW4536	Control software	

BGV INTEGRATION

RPT crate :

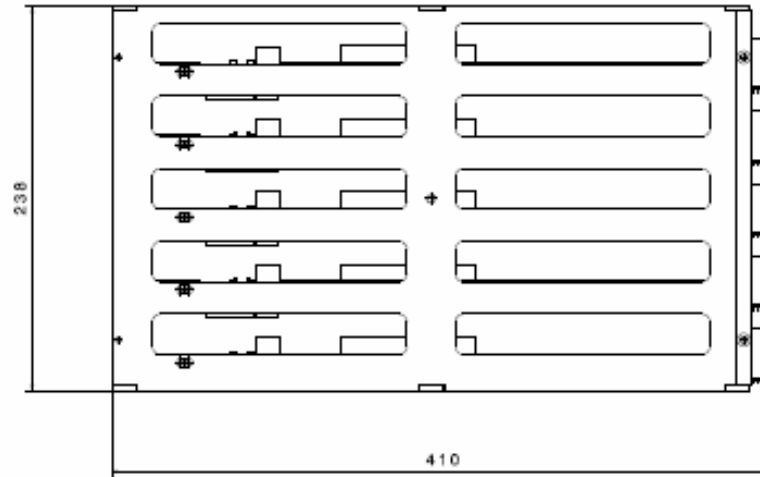
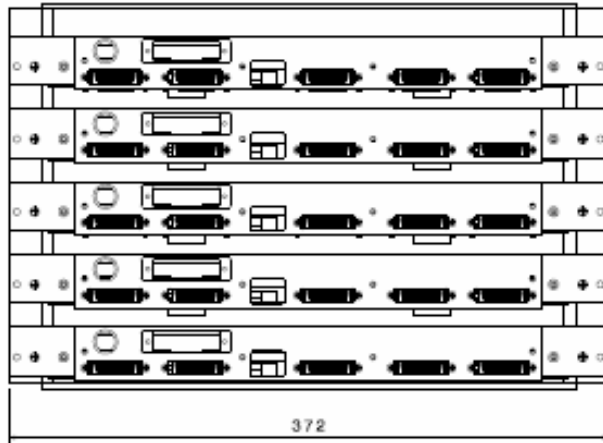

- New design 372 x 410 x 238 mm
- RPT fanout card plugged in RPT board
- must include 2 LV Dsub 15P connector

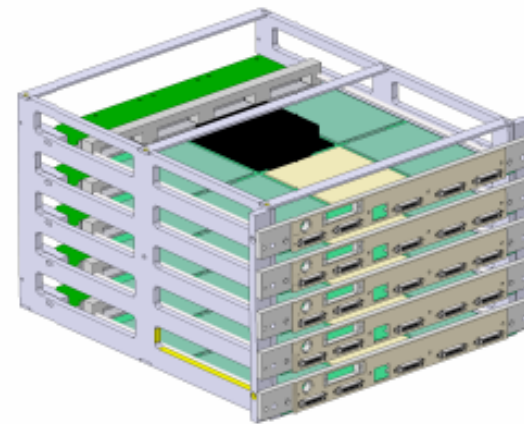
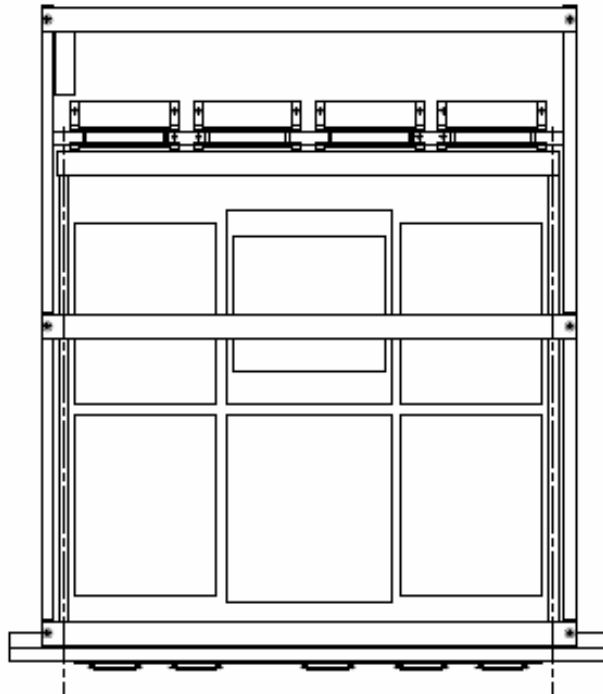

BGV INTEGRATION

RPT LV patch panel:

Surface : 440 x 350 mm
- distance from floor : ?
- cable shield connection : to be defined

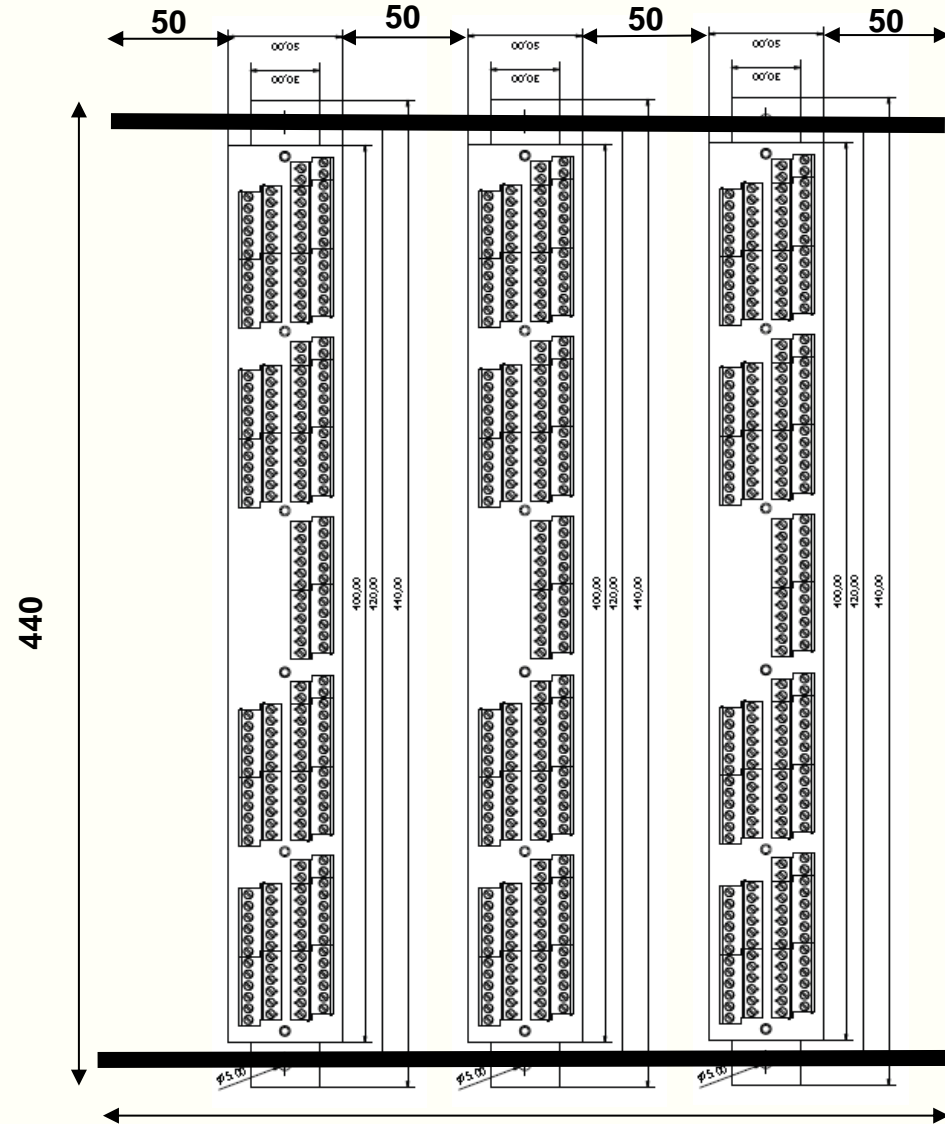

BGV INTEGRATION

NTC and Bias patch panel:

Can be mounted
on a frame
Surface : 510 x 420 mm

Could be split
Into 2 parts

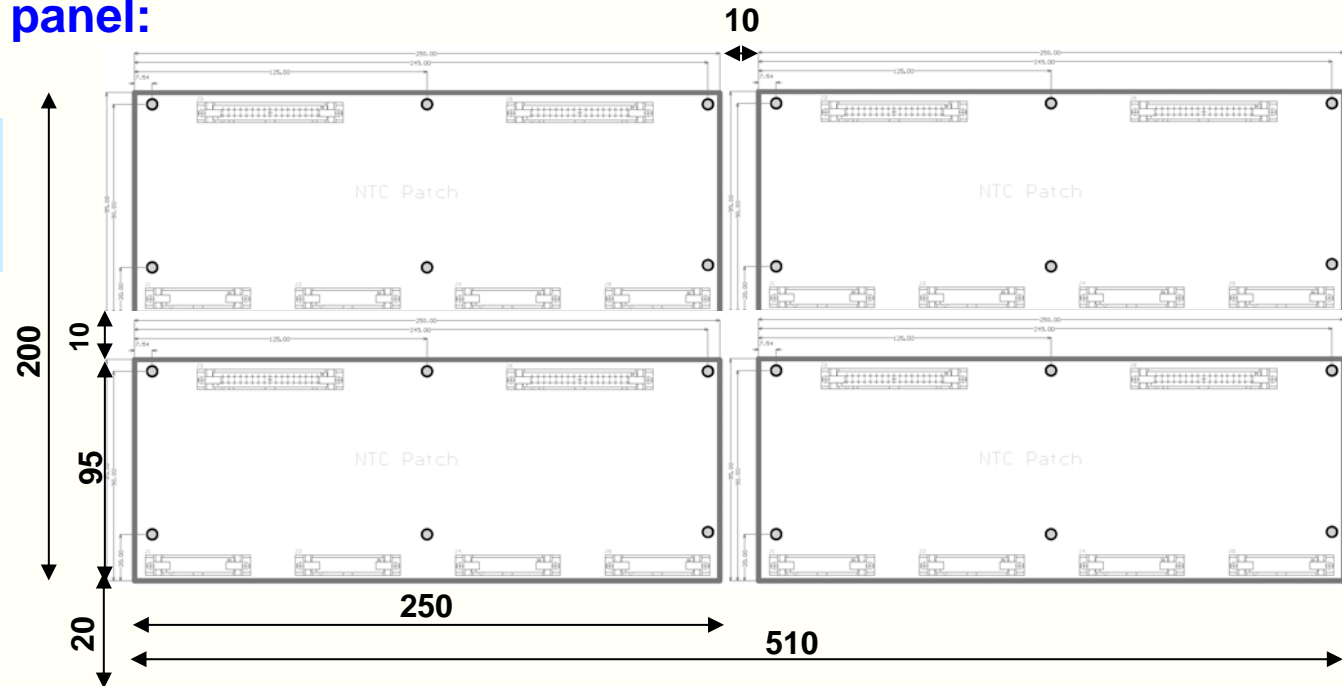

**Bias patch panel
200 x 510**

BGV INTEGRATION

Discussion :