

Feynman Diagrams for FourTop Processes

Alejandro Gomez Espinosa

October 30, 2011

1 FourTop

1.1 Simple FourTop

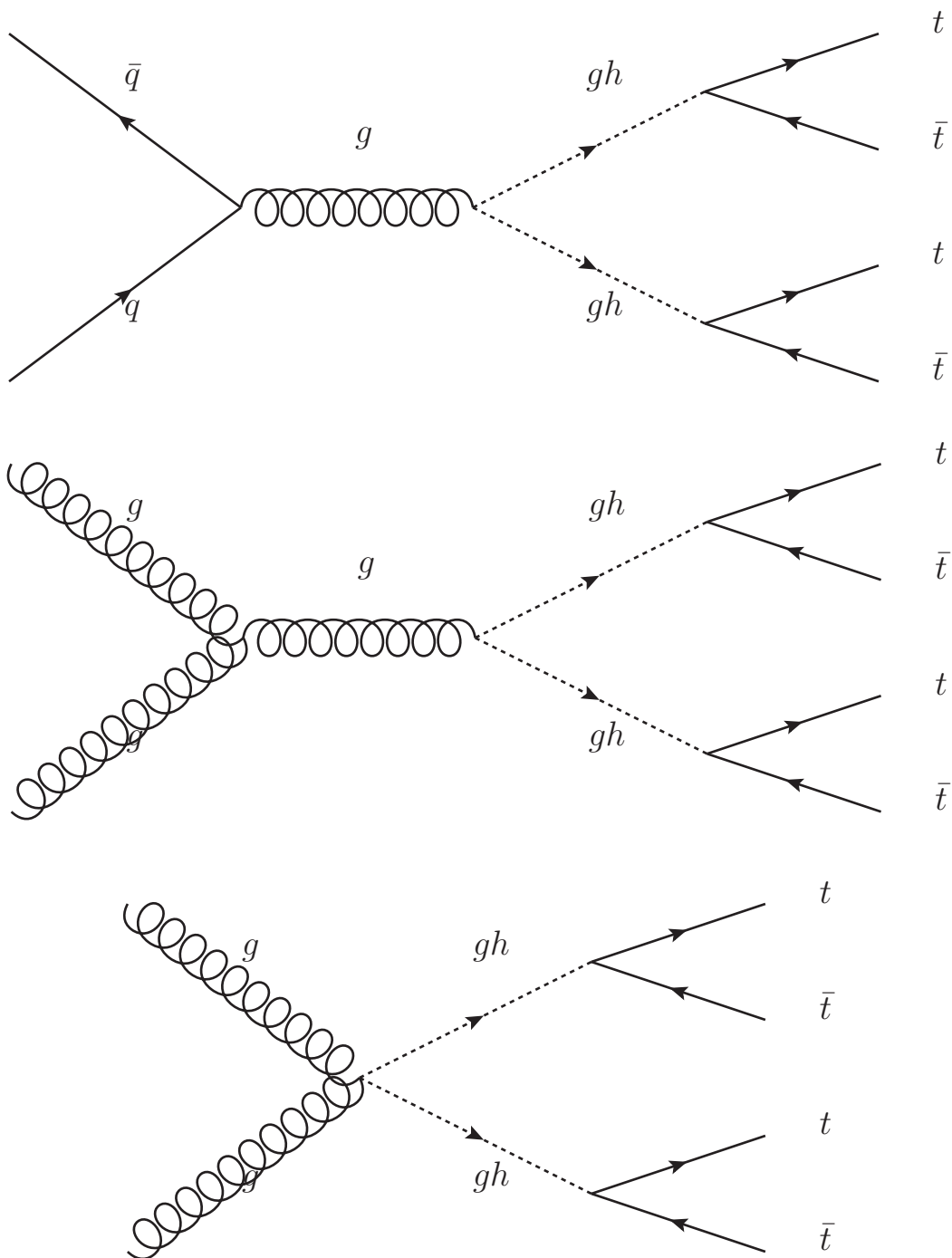

1.2 FourTop with ttbar decays

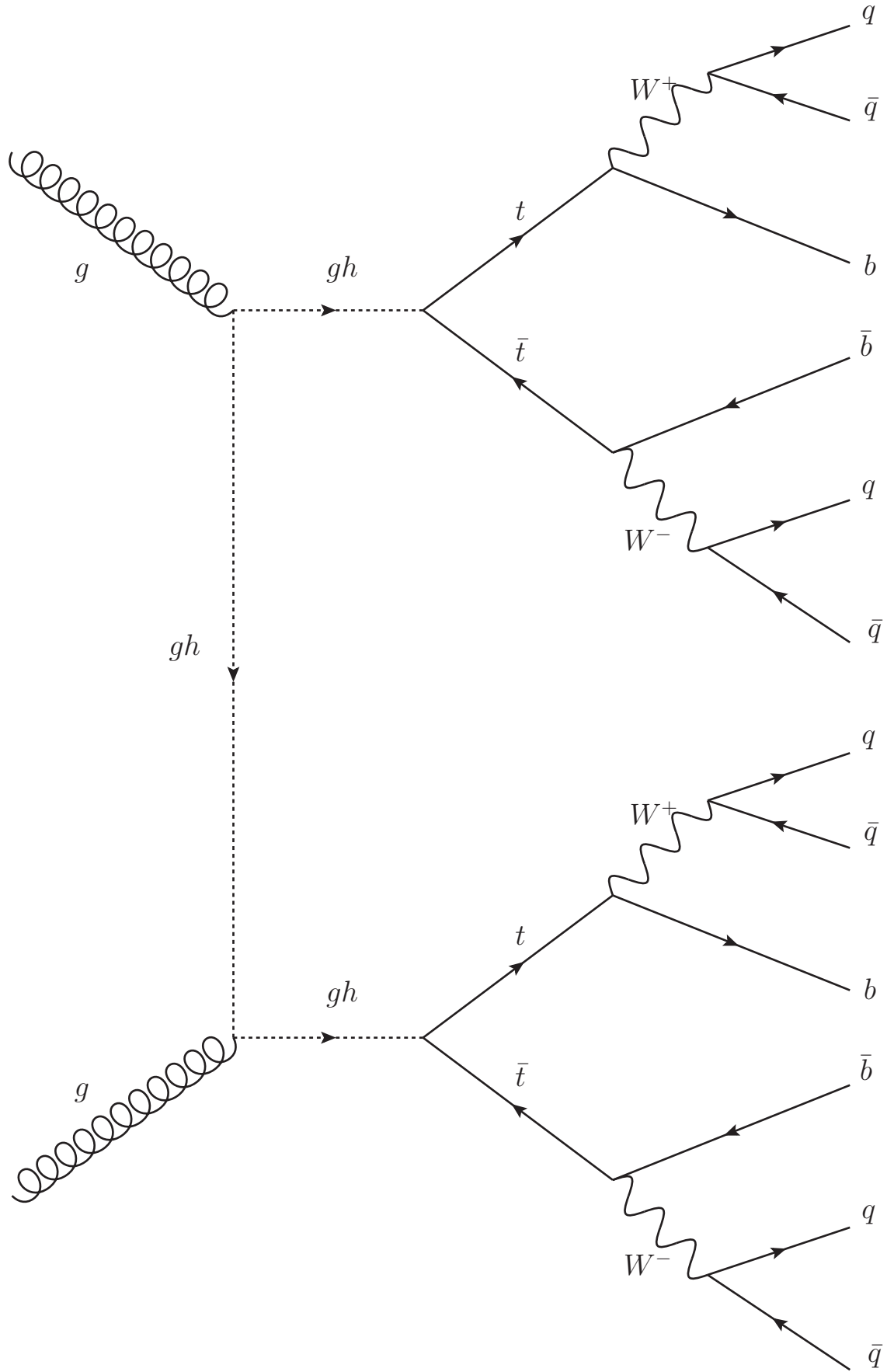

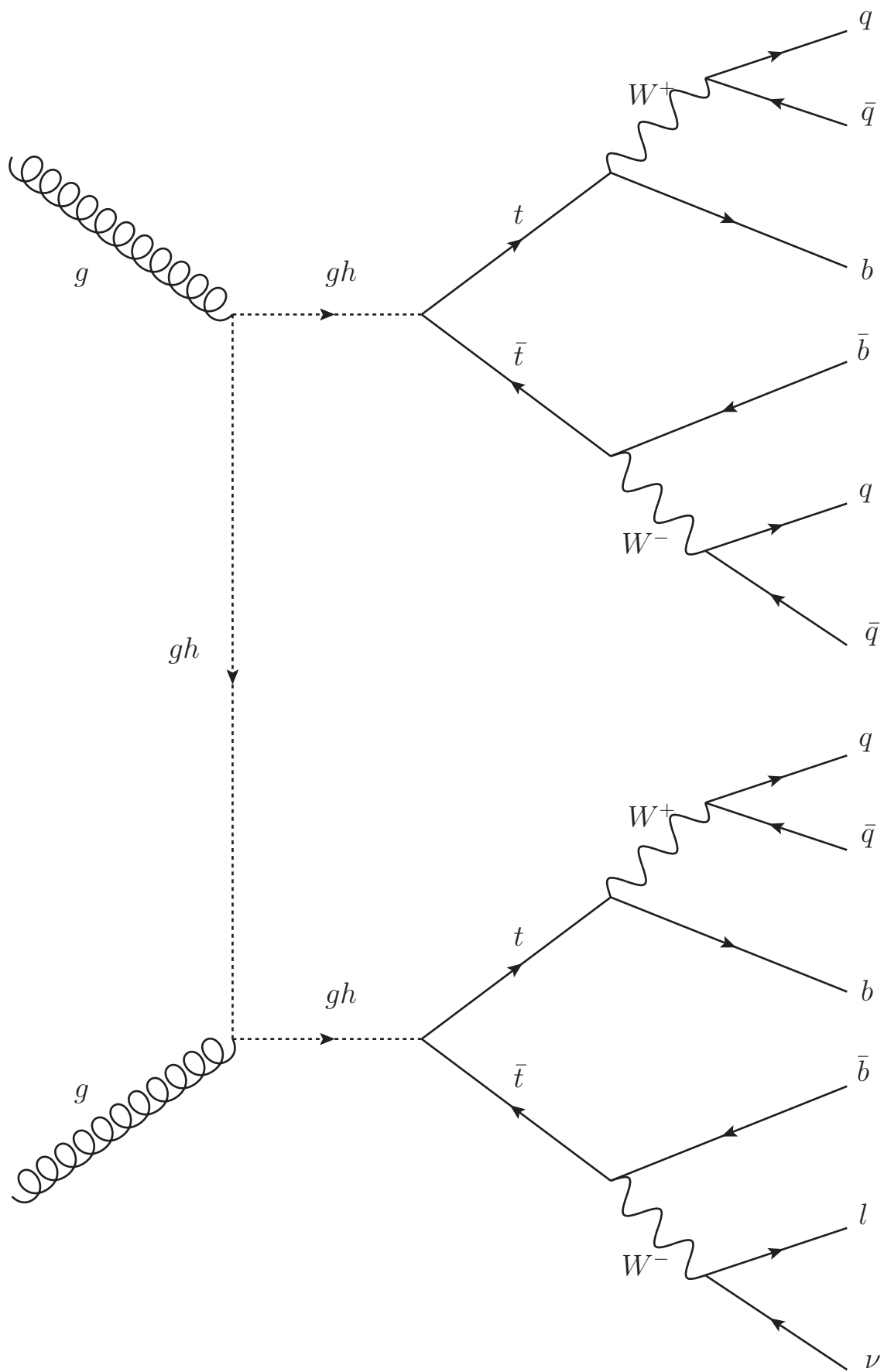

2 Background Processes

2.1 Single Top

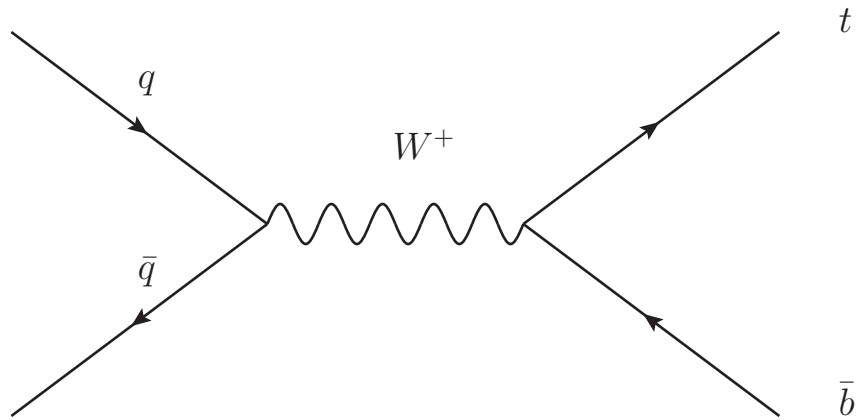

2.2 $t\bar{t}$ bar

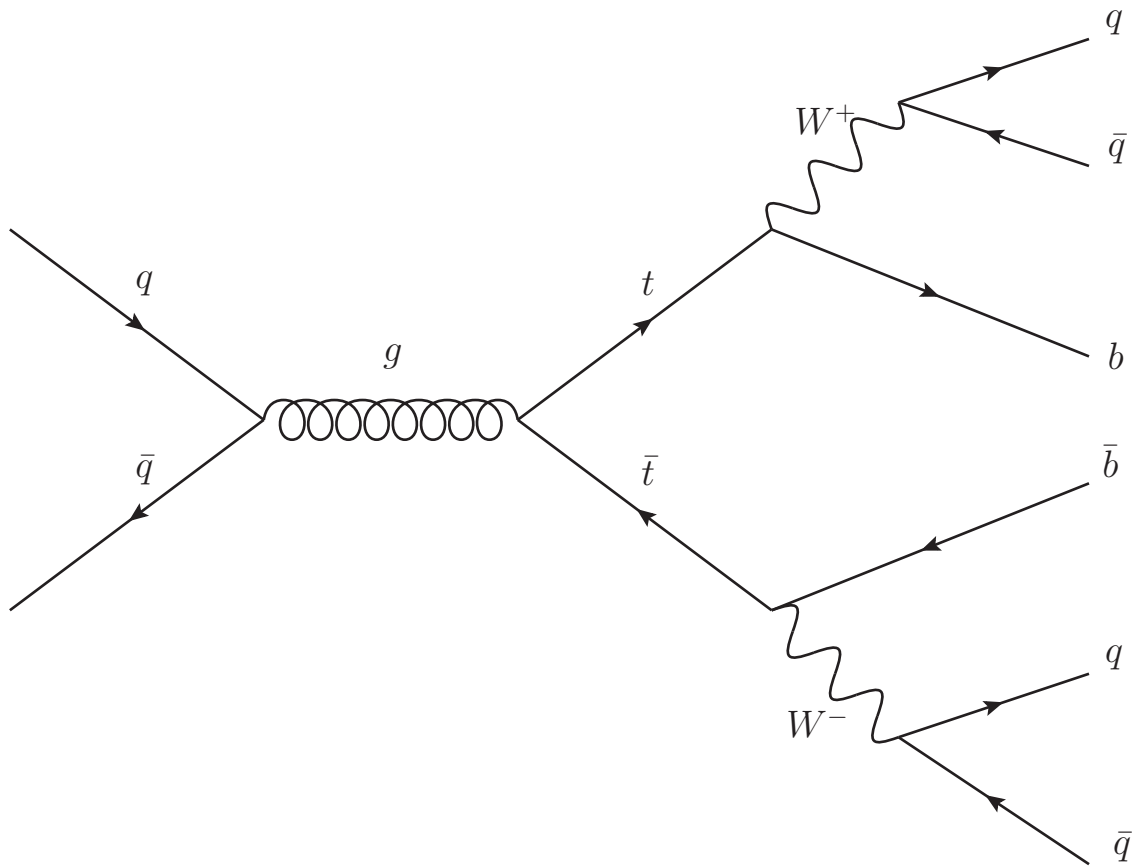

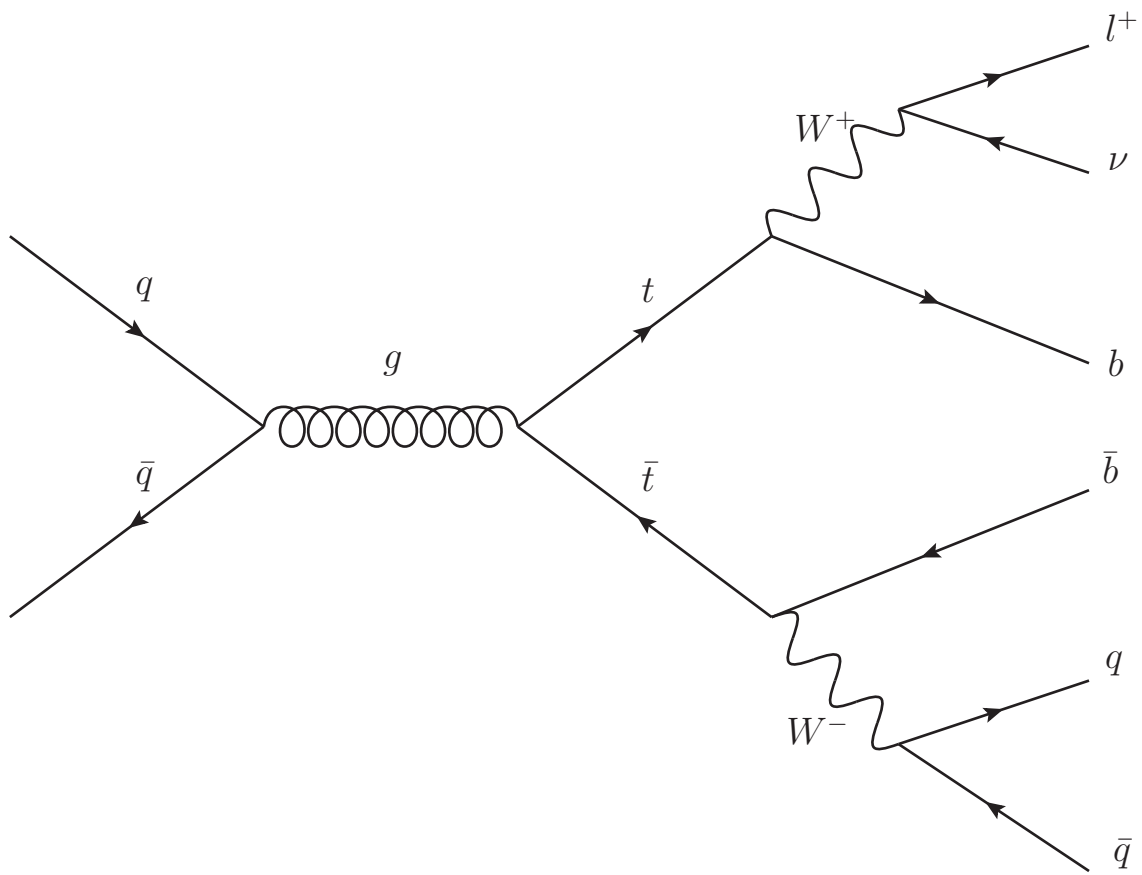

2.3 W + jets

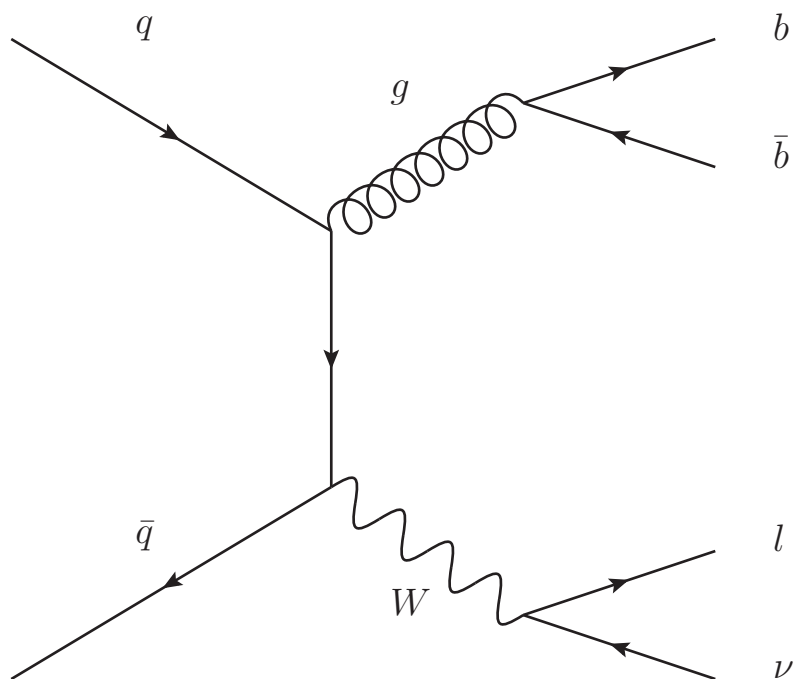

2.4 QCD Processes

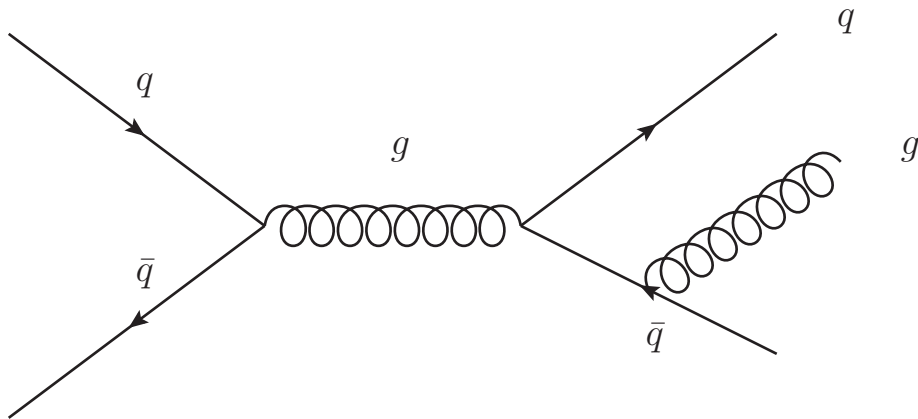

3 LO, NLO, NNLO W + jets

3.1 LO W + jets

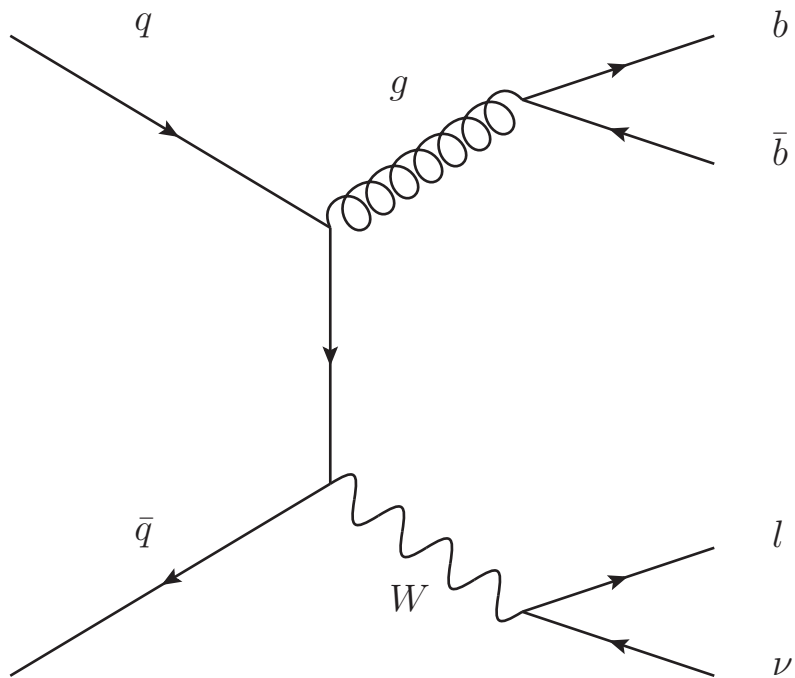

3.2 NLO W + jets

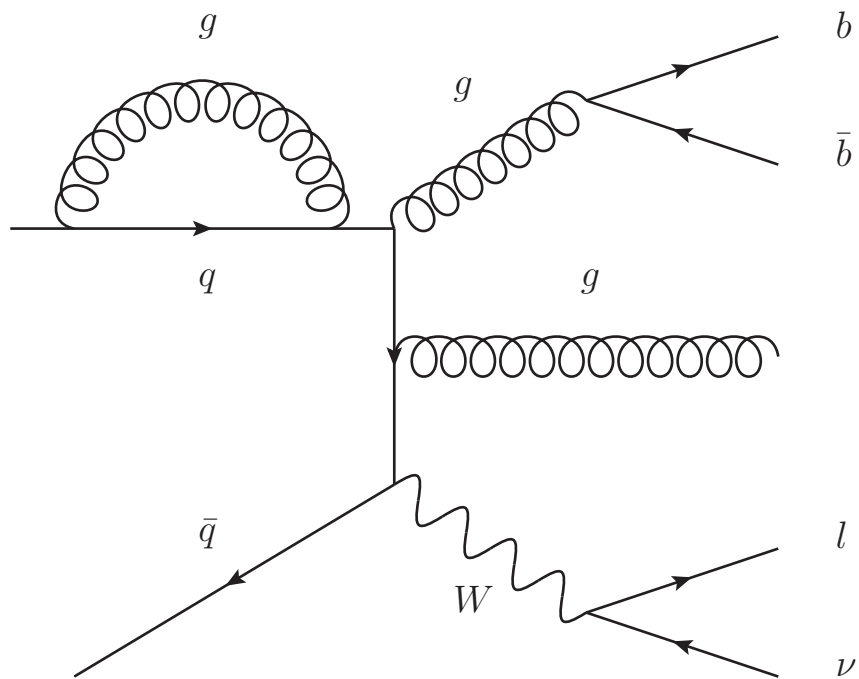

3.3 NNLO W + jets

