

MCS2

USER MANUAL



www.smaract.com





Copyright © 2019 SmarAct GmbH

Specifications are subject to change without notice. All rights reserved. Reproduction of images, tables or diagrams prohibited.

The information given in this document was carefully checked by our team and is constantly updated. Nevertheless, it is not possible to fully exclude the presence of errors. In order to always get the latest information, please contact our technical sales team.

SmarAct GmbH, Schuette-Lanz-Strasse 9, D-26135 Oldenburg
Phone: +49 (0) 441 - 800879-0, Telefax: +49 (0) 441 - 800879-21
Internet: www.smaract.com, E-Mail: info@smaract.com

Document Version: 1.1.5

TABLE OF CONTENTS

1	Manufacturer Declarations	5
1.1	Declaration of Conformity	5
1.2	Information, Warnings and Safety Instructions	6
1.2.1	Information – Intended Use	6
1.2.2	Danger – Hazardous Voltage	6
1.2.3	Caution – Unpacking	7
1.2.4	Caution – Installation Instructions	7
1.2.5	Caution – Connecting Instructions	8
1.2.6	Caution – Disposal of Old Equipment	8
1.2.7	Warranty and Liability	9
1.2.8	Life Support Policy	9
1.2.9	Note for USB Devices	9
2	Product Overview	10
2.1	MCS2 Main Controller	11
2.1.1	I/O Modules	14
2.2	MCS2 Sensor Module	16
2.3	MCS2 Accessories	16
3	Installation and Operation	17
3.1	Setting up the Device	17
3.2	Ethernet Interface Configuration	18
3.2.1	Integrated Web Server	19
3.2.2	Hand Control Module	20
3.2.3	SmarActNetConfig Tool	20
3.3	Finding An Unknown IP Address	20
4	Technical Data	22
4.1	Status LED	22
4.2	MCS2 Main Controller Connectors	22
4.2.1	Power Supply Connectors	22
4.2.2	D-SUB-15 Connector for Sensor Module	24
4.2.3	D-SUB-15-HD Connector for External Hand Control Module	24
4.2.4	USB Connector	25
4.2.5	RJ-45 Connector for Ethernet Communication	25
4.2.6	BNC Connectors for Fast Digital Input/Outputs	26
4.2.7	D-SUB-37 Connector of Auxiliary I/O	26
4.3	MCS2 Sensor Module Connectors	28
4.3.1	D-SUB-15 Positioner Connectors	28
4.4	MCS2 Electrical Specifications	29
4.4.1	Positioner Driver Output	29

4.4.2	Auxiliary Fast Digital Input/Outputs	29
4.4.3	Auxiliary GP Digital Inputs/Outputs	30
4.4.4	Auxiliary GP Analog Outputs	31
4.4.5	Auxiliary Fast Analog Inputs	32
4.4.6	Abbreviations	34

1 MANUFACTURER DECLARATIONS

1.1 Declaration of Conformity

according to DIN EN ISO/IEC 17050-1:2010

Manufacturer: SmarAct GmbH
Manufacturer's Address: Schuette-Lanz-Strasse 9
26135 Oldenburg, Germany



The manufacturer hereby declares that the product

Product name: MCS2
Model Numbers: MCS2-C-xxxx, MCS2-S-xxxx, MCS2-H-xxxx,
MCS2-R19-xxxx, MCS2-MOD-xxxx
Product Options: all

complies - if installed in a compatible chassis from SmarAct and connected to a power supply provided by SmarAct - with the following European directives:

2014/35/EC	Low Voltage Directive
2014/30/EC	EMC Directive
2011/65/EU	RoHS Directive

The applied standards certifying the conformity are listed below:



Electromagnetic Emission:	EN61000-6-3:2011, EN55011:2011 (Group 1, Class A)
Electromagnetic Immunity:	EN61000-6-1:2007
Safety (Low Voltage Directive):	EN61010-1:2011-07

July 3, 2018
Oldenburg, Germany

Axel Kortschack
Managing Director

1.2 Information, Warnings and Safety Instructions

Please read the following information, warnings and safety instructions in this section carefully before using the product. The symbols and labels in this manual have the following definitions:

Symbol	Definition
	This symbol identifies conditions or practices that could result in damage to the equipment or other property, and in extreme cases, possible personal injury or death.
	This symbol identifies conditions or practices that involve potential electric shock hazard.

1.2.1 Information – Intended Use

The SmarAct MCS2 controllers are designed to drive SmarAct positioners only. Never connect any other equipment than SmarAct positioners to the MCS2 controller outputs.

SmarAct MCS2 controllers are laboratory equipment designed according to the safety requirements for electrical equipment for measurement, control and laboratory use (DIN EN 61010).

The MCS2 controller should be operated under the following environmental conditions:

- Indoor use only
- Altitude up to 2000 m
- Temperature range from 5 °C to 40 °C
- Maximum relative humidity 80% up to 31 °C, decreasing linearly to 50% relative humidity at 40 °C
- Degree of pollution: 2

Please use the provided power supply only. This is required to meet all design specifications.

1.2.2 Danger – Hazardous Voltage

The MCS2 controller described in this manual is capable of generating high output currents at high voltages. They may cause serious or even lethal injury if used improperly. Therefore, the equipment should only be operated by personnel that is adequately trained and educated to prevent any improper use.

Please note the following general accident prevention rules:



DANGER

- Never touch any part that might be connected to an output with a high voltage.
- Do not connect products from other manufacturers to the output connectors.
- Never use equipment that is damaged in any way.
- The MCS2 controller contains no user serviceable parts. Never open the housing. Procedures which require to open the housing must only be carried out by authorized, qualified and trained personnel.

Output connectors with dangerous signals are labeled with the following symbol:



WARNING

The Sensor Modules connected to these output connectors have pins with a high voltage, too.

1.2.3 Caution - Unpacking

Please be careful when unpacking the MCS2 controller. Inspect the MCS2 controller for signs of damage and only use equipment that shows no signs of damage. In case of any damage, contact SmarAct for replacement. Please save all packing materials in case you would like to transport or ship the product again.

1.2.4 Caution - Installation Instructions

The MCS2 controller must be installed horizontally with 3 cm air circulation area behind the fan. Insufficient air flow can cause overheating, which can result in a limited functionality of the controller.

If you are using an OEM version of an MCS2 controller, the controller board must be installed in such a way, that free air convection can be achieved. Insufficient ventilation will cause overheating and premature failure. Therefore forced air cooling, for example in a rack with a fan, is preferred. Make sure that no part of the MCS2 OEM controller board other than the required connectors can be touched after final installation. Please take care to meet all applicable requirements concerning electrical equipment in your regulatory domain.

**CAUTION**

Avoid touching any circuit components, pins or PCB traces, as these components are ESD-sensitive devices.

Please touch the OEM boards on their edges only during handling and installation. Discharge any static charge on your body by touching a grounded object prior to the handling of the MCS2 controller board. If not installed, place the MCS2 controller boards only on conductive surfaces, such as ESD- safe transport containers (envelopes or foam).

Only apply power to the MCS2 OEM controller board if it is installed in the intended housing. Never apply power to a MCS2 OEM controller board if any other part than the required connectors can be touched.

1.2.5 Caution – Connecting Instructions

Never use any other connecting cables than the connecting gear that you obtained from SmarAct. Never use any third party adapters or cables. This can cause failure or malfunction.

**NOTICE**

When removing the USB or Ethernet cable, all positioners will be stopped immediately as a safety precaution.

1.2.6 Caution – Disposal of Old Equipment

According to the EU directive 2012/19/EU, as of August 13th, 2012, electrical and electronic equipment may not be disposed of with other wastes in the member states of the European Union.

SmarAct respects the manufacturer's product responsibility and will take care of environmentally correct disposal of old SmarAct products free of charge.

To dispose of old SmarAct equipment, you can return it to SmarAct to the following address postage-free:

SmarAct GmbH
Schuette-Lanz-Strasse 9
26135 Oldenburg, Germany



WEEE-Reg.-Nr.: DE 47992153

1.2.7 Warranty and Liability

The General Terms and Conditions of Sale and Delivery from SmarAct GmbH always apply. These conditions are available to the operator upon signing the contract, placing an order or at <http://www.smaract.com/site-notice/>. No warranty or liability claims may be made in the event of injury to persons or damage to property if this has arisen from one or more of the following:

- Improper use of the unit,
- incorrect assembly, startup and operation,
- operation with defective and/or non-functional safety and protective devices,
- failure to comply with the information in the operating instructions regarding safety, transport, storage, mounting/installation, commissioning, operation and maintenance of the unit,
- incorrectly or unauthorized repairs,
- unauthorized modifications to the device,
- inadequate monitoring of parts which are subject to wear,
- damage caused by exposure to water, e.g. condensation water formation, where this is outside the responsibility of SmarAct GmbH,
- the effect of foreign bodies or mechanical damage,
- disastrous occurrences,
- force majeure.

Please refer to section 1.2.6 for the contact address for claims under warranty, repair and replacement service.

1.2.8 Life Support Policy

SmarAct GmbH does not authorize or warrant any of its products for use in life support systems, without the specific written consent of SmarAct GmbH.

Life support systems are equipment intended to support or sustain life, and whose failure to perform, when properly used in accordance with instructions provided, can be reasonably expected to result in personal injury or death.

1.2.9 Note for USB Devices

Devices with a USB interface operate stable even under conditions where electric transients occur. However, the USB connection to the device may fail from the perspective of the connected host device. In this case a reconnect must be issued by the software application to continue operation.

A special API property may be configured to perform an auto-reconnect in these situations. Please refer to the MCS2 Programmer's Guide for detailed information.

2 PRODUCT OVERVIEW

This document is a user manual for the SmarAct Modular Control System 2 (MCS2) which is designed to drive piezo based SmarAct stepping actuators.

For the general concepts of controlling the MCS2 by software as well as for a description of the application programming interface (API) please refer to the *MCS2 Programmers Guide*.

Each MCS2 control device consists of the following components:

- **MCS2 Main Controller**

The main controller has the following tasks:

- process commands from the hand control module or from the user application software
- read in the sensor data from the integrated position sensors (via sensor module)
- perform closed-loop position control
- drive the positioners

Each MCS2 controller is equipped with a USB or Network Interface and can be controlled by software running on a PC.

- **MCS2 Sensor Module**

The positioners may be equipped with integrated sensors to perform closed-loop positioning control. For this, a sensor module preprocesses the sensor data and delivers the digitized data to the main controller. Alternatively, a SmarAct PicoScale interferometer can be used as a sensor module. Each sensor module can handle up to three positioners.

- **Hand Control Module (optional)**

The MCS2 offers easy and ready-to-go control by joysticks and control knobs - without the need of complex installation procedures or software development. The Hand Control Module may be integrated into the main controller or placed inside a separate (external) housing.

- **I/O Module (optional)**

The MCS2 can be equipped with I/O modules that provide digital and analog inputs and outputs. Fast digital outputs can be used to trigger external devices on specific internal events of the main controller (e.g. Position Reached). Digital device inputs allow to trigger the MCS2 by an external device for example to perform an Emergency Stop or to synchronize data streaming. General purpose digital inputs and outputs provide control signals to switch lights, relays, dispensers, etc. or to read the state of safety switches, light barriers, etc. Analog inputs can be used to read analog voltage signals from external devices. The controller supports to feed these signals into the control loop. Closed loop operation depending on external sensor signals can be implemented with this feature.

The I/O module is integrated into the main controller.

Figure 2.1 shows a structural setup of a typical MCS2 system.

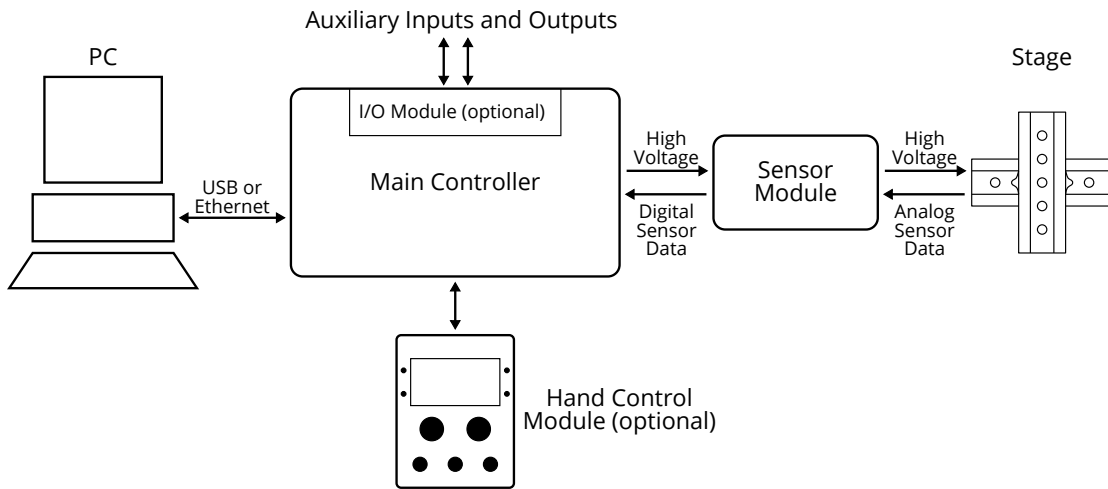

Figure 2.1: Structural Setup of an MCS2 Device

Note that all external connections support hot-plugging. The controller will automatically detect and report a changed configuration. If the connection to the PC or Hand Control Module is unplugged, all movements that were sent over the disconnected interface are stopped as a safety measure.

As there is a wide range of applications, many different combinations of MCS2 main controllers and sensor modules are configurable to meet the individual needs of our customers. Sections 2.1 and 2.2 give an overview on current models.

2.1 MCS2 Main Controller

MCS2 main controllers are available with different housing, a selectable number of channels and an interface option which offers all the connectivity needed. The configuration of your product is defined by the product code below and the options listed in table 2.1.

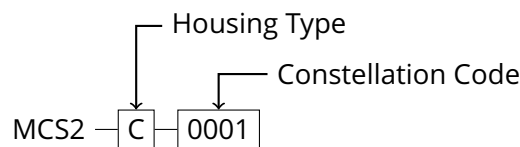

Table 2.1 – Product Codes

Product Code	Description	Connectors
<i>Table Top Housing (Type C)</i>		

Continued on next page

Table 2.1 – Continued from previous page

Product Code	Description	Connectors
MCS2-C-0001	3 channel Controller, integrated Hand Control Module, USB interface	USB type B, D-SUB-15 female (Sensor Module)
MCS2-C-0002	3 channel Controller, USB interface	USB type B, D-SUB-15 female (Sensor Module), D-SUB-15-HD female (ext. Hand Control Module)
MCS2-C-0003	6 channel Controller, USB interface	USB type B, D-SUB-15 female (Sensor Module)
MCS2-C-0004	9 channel Controller, USB interface	USB type B, D-SUB-15 female (Sensor Module)
MCS2-C-0005	3 channel Controller, integrated Hand Control Module, Ethernet interface	RJ-45 Ethernet, D-SUB-15 female (Sensor Module)
MCS2-C-0006	3 channel Controller, Ethernet interface	RJ-45 Ethernet, D-SUB-15 female (Sensor Module)
MCS2-C-0007	6 channel Controller, Ethernet interface	RJ-45 Ethernet, D-SUB-15 female (Sensor Module)
MCS2-C-0008	9 channel Controller, Ethernet interface	RJ-45 Ethernet, D-SUB-15 female (Sensor Module)
MCS2-C-0009	3 channel Controller, I/O Module Type 3, USB interface	USB type B, D-SUB-15 female (Sensor Module), 4x BNC (3 out, 1 in)
MCS2-C-0010	12 channel Controller, USB interface	USB type B, D-SUB-15 female (Sensor Module)
MCS2-C-0011	12 channel Controller, Ethernet interface	RJ-45 Ethernet, D-SUB-15 female (Sensor Module)
MCS2-C-0012	3 channel Controller, I/O Module Type 5, USB interface	USB type B, D-SUB-15 female (Sensor Module), 3x BNC (3 out), USB type B (HSDR)
MCS2-C-0013	3 channel Controller, I/O Module Type 5, Ethernet interface	RJ-45 Ethernet, D-SUB-15 female (Sensor Module), 3x BNC (3 out), USB type B (HSDR)
MCS2-C-0014	6 channel Controller, I/O Module Type 3, Ethernet interface	RJ-45 Ethernet, D-SUB-15 female (Sensor Module), 4x BNC (3 out, 1 in)
MCS2-C-0015	6 channel Controller, I/O Module Type 1/3, Ethernet interface	RJ-45 Ethernet, D-SUB-15 female (Sensor Module), 7x BNC (6 out, 1 in)
MCS2-C-0016	3 channel Controller, I/O Module Type 3, Ethernet interface	RJ-45 Ethernet, D-SUB-15 female (Sensor Module), 4x BNC (3 out, 1 in)

Continued on next page

Table 2.1 – Continued from previous page

Product Code	Description	Connectors
MCS2-C-0017	3 channel Controller, I/O Module Type 4, USB interface	USB type B, D-SUB-15 female (Sensor Module), D-SUB-37 female (IO) 1x BNC (1 in)
MCS2-C-0018	3 channel Controller, I/O Module Type 4, Ethernet interface	RJ-45 Ethernet, D-SUB-15 female (Sensor Module), D-SUB-37 female (IO) 1x BNC (1 in)
MCS2-C-0019	9 channel Controller, I/O Module Type 3, USB interface	USB type B, D-SUB-15 female (Sensor Module), 4x BNC (3 out, 1 in)
MCS2-C-0020	9 channel Controller, I/O Module Type 3, Ethernet interface	RJ-45 Ethernet, D-SUB-15 female (Sensor Module), 4x BNC (3 out, 1 in)
MCS2-C-0021	3 channel Controller, I/O Module Type 6, USB interface	USB type B, D-SUB-15 female (Sensor Module), D-SUB-37 female (IO), USB type B (HSDR)

The connectors of the most common MCS2 controllers are shown in the following figures.

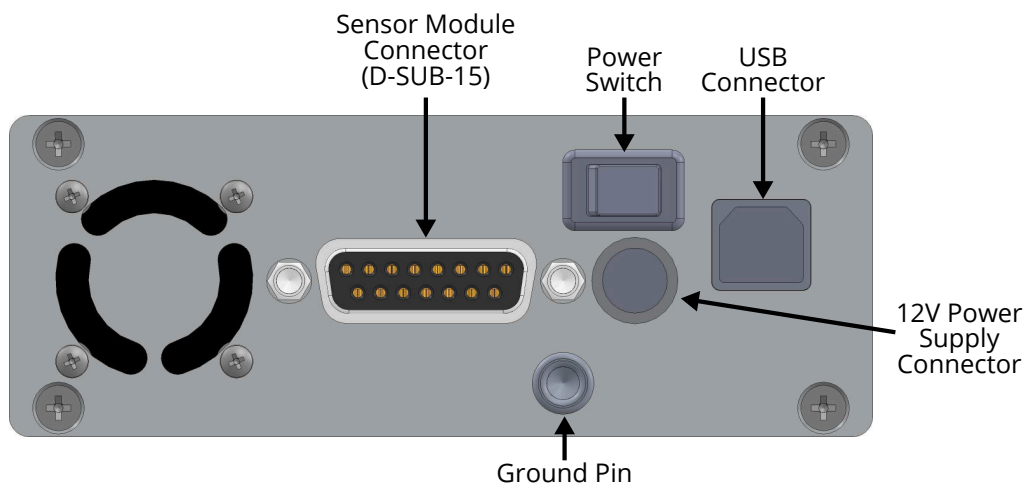

Figure 2.2: Three Channel MCS2 Table Top Housing (front view)

Depending on the computer interface the arrangement is a bit different. Controllers with more channels that are delivered in a table-top housing have the same connectors as in the figures, but are equipped with additional D-SUB-15 connectors to the sensor modules.

2.1.1 I/O Modules

Depending on a specific product code the MCS2 may be equipped with one or more I/O modules. The following tables list the currently available I/O module types and their features:

I/O Module Type 1

Table 2.2 – I/O Module Type 1

Name	Type	Connectors	Function
DOUT-n	3 Fast Digital Outputs	BNC	Output Trigger: Position Compare, Position Reached, Actively Moving

I/O Module Type 3

Table 2.3 – I/O Module Type 3

Name	Type	Connectors	Function
DIN-1	1 Digital Device Input	BNC	Input Trigger: Emergency Stop, Trajectory Streaming Synchronization, Command Group Trigger
DOUT-n	3 Fast Digital Outputs	BNC	Output Trigger: Position Compare, Position Reached, Actively Moving

I/O Module Type 2

Table 2.4 – I/O Module Type 2

Name	Type	Connectors	Function
DIN-1	1 Digital Device Input	D-SUB37	Input Trigger: Emergency Stop, Trajectory Streaming Synchronization, Command Group Trigger
DOUT-n	3 Fast Digital Output	D-SUB37	Output Trigger: Position Compare, Position Reached, Actively Moving
GP-DIN-n	4 Digital Inputs	D-SUB37	General Purpose Digital Input
GP-DOUT-n	4 Digital Outputs	D-SUB37	General Purpose Digital Output, Open-Collector
AOUT-n	2 Analog Outputs	D-SUB37	General Purpose +/-10V Analog Voltage Output

Continued on next page

Table 2.4 – Continued from previous page

Name	Type	Connectors	Function
AIN-n	6 Fast Analog Inputs	D-SUB37	General Purpose Analog Input, Control Loop Feedback

I/O Module Type 4

Table 2.5 – I/O Module Type 4

Name	Type	Connectors	Function
DIN-1	1 Digital Device Input	D-SUB37 / BNC	Input Trigger: Emergency Stop, Trajectory Streaming Synchronization, Command Group Trigger
DOUT-n	3 Fast Digital Output	D-SUB37	Output Trigger: Position Compare, Position Reached, Actively Moving
GP-DIN-n	4 Digital Inputs	D-SUB37	General Purpose Digital Input
GP-DOUT-n	4 Digital Outputs	D-SUB37	General Purpose Digital Output, Open-Collector
AOUT-n	2 Analog Outputs	D-SUB37	General Purpose +/-10V Analog Voltage Output
AIN-n	6 Fast Analog Inputs	D-SUB37	General Purpose Analog Input, Control Loop Feedback

I/O Module Type 6

Table 2.6 – I/O Module Type 6

Name	Type	Connectors	Function
DIN-1	1 Digital Device Input	D-SUB37	Input Trigger: Emergency Stop, Trajectory Streaming Synchronization, Command Group Trigger
DOUT-n	3 Fast Digital Output	D-SUB37	Output Trigger: Position Compare, Position Reached, Actively Moving
GP-DIN-n	4 Digital Inputs	D-SUB37	General Purpose Digital Input
GP-DOUT-n	4 Digital Outputs	D-SUB37	General Purpose Digital Output, Open-Collector
AOUT-n	2 Analog Outputs	D-SUB37	General Purpose +/-10V Analog Voltage Output

Continued on next page

Table 2.6 – Continued from previous page

Name	Type	Connectors	Function
AIN-n	6 Fast Analog Inputs	D-SUB37	General Purpose Analog Input, Control Loop Feedback
HSDR	1 USB Interface	USB type B	High Speed Data Reader

2.2 MCS2 Sensor Module

For positioners with integrated sensors a sensor module is required to digitize the sensor data. The sensor module type depends on the sensor type, the driver type and the connector to the positioner. The configuration of the sensor module is defined by the product code below. In table 2.7 you will find all available configuration options.

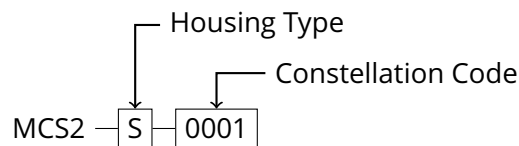

Table 2.7 – Product Codes

Product Code	Description	Connectors
MCS2-S-0001	Sensor Module for up to 3 positioners	3x D-SUB-15 female

2.3 MCS2 Accessories

In addition to the modules above, some optional accessories may be required for specific configurations. In table 2.8 you will find a list of available accessories.

Table 2.8 – Product Codes

Product Code	Description	Connectors
MCS2-A-PS-CABLE-1.5M-1.5M	Adapter cable for MCS2 and PicoScale	3x D-SUB-15 female

3 INSTALLATION AND OPERATION

3.1 Setting up the Device

Before initial operation be sure to read the safety notes in chapter 1. To set up your MCS2 device please follow the instructions below:

1. Make sure that the **power switch** of your MCS2 controller is in the **off** position (0) or that the MCS2 control module is not supplied with power, respectively.
2. **Connect the Sensor Modules**, which may be integrated into the manipulator base plate, to the D-SUB 15 pin female connector(s) of the MCS2 controller. If the connectors are labeled, their labels must match.
3. If the cables from the positioners or Sensor Modules are delivered with feed-throughs, **install the feed-throughs** at a flange of the vacuum chamber and connect the matching connectors to both sides of the feed-through. If the connectors are labeled, their labels must match.
4. If the Sensor Modules are delivered in a separate housing, **connect the positioners** to the D-SUB 15 pin female connectors of the Sensor Modules. If the connectors are labeled, their labels must match.
5. If the Hand Control Module is delivered in a separate housing, connect the **Hand Control Module** to the D-SUB 15 pin high-density female connector of the MCS2 main controller using the enclosed cable.
6. If desired, **connect the ground potential** of the mechanical system setup to the ground pin of the MCS2 controller. This is recommended for applications in scanning electron microscopes where the ground potential of the system setup should be equivalent to the ground potential of the controllers.
7. **Connect the power supply**, which has been delivered with the controller, to the power supply connector of the MCS2 controller.
8. **Connect the MCS2 controller** with one of the following **interface** cables:
 - USB cable to the PC
 - Ethernet cable to a switch or PC
9. Power up the controller by switching the **power switch** to the **on** position (I).
10. The positioning system now can be controlled by software. Make sure that the correct **positioner types** are configured for your positioners and perform the **calibration routine** on the controller for each channel.

**NOTICE**

When using positioners with **M- or L-sensor** on *at least one* channel of a specific driver module *all* positioner types of *this* module must be set to a **M- or L-sensor** type too to configure the correct sensor supply voltage. This rule applies even if the other channels of the driver module are unused, respectively no positioners are connected.

For getting started the *MCS2 Demo GUI* delivered with each MCS2 device may be used. The *MCS2 Service Tool* allows to easily configure and setup the MCS2 controller. For detailed information on these programs please refer to the specific manuals.

To create your personal software SmarAct delivers flexible and well documented Windows® and Linux libraries. For those who like to use LabVIEW™, we provide ready-to-use VIs based on the Windows® DLL. Programming examples for C and LabVIEW™ allow the developer a quick start into the application programming with the MCS2.

For more information on the available software please refer to the MCS2 Software Installation documentation.

3.2 Ethernet Interface Configuration

While devices with USB interface do not need any interface configuration, the ethernet interface must be configured with the network parameters: DHCP mode, IP address, subnet mask and gateway IP address. The MCS2 is delivered with a default IP configuration which may be adjusted to match the users network settings.

The following table lists the default configuration:

Parameter	Default Value
DHCP Mode	disabled
IP Address	192.168.1.200
Subnet Mask	255.255.0.0
Gateway IP	192.168.1.1
Pass-Key	smaract

The MCS2 offers several ways to configure the network parameters. These are described in detail in the following sections.

In general, the interface may be configured to use DHCP to obtain an IP address from a DHCP-server or to use a static IP configuration.

3.2.1 Integrated Web Server

The built-in web server is accessible with any internet browser (e.g. Firefox®). Obviously, the current IP address of the controller must be known to be able to connect to the web server. Furthermore, the MCS2 and the PC need to be on the same network to enable the browser to load the configuration web page.

- Open the internet browser and type the IP address of the controller in the address bar. The default IP is: 192.168.1.200.
- Press 'Enter' to access the webserver.

The following webpage should be displayed:

Figure 3.1: Device Information Tab of the Webpage

The **'Information'** tab gives some general information about the device, like serial number, device name, number of channels, etc.

Figure 3.2: Configuration Tab of the Webpage

The '**Configuration**' tab shows the current network configuration and allows to configure the interface. Note that changes only become effective after the configuration was saved. The configuration is protected against unintentional modification by a pass-key.

- To enable the **DHCP** mode, select the 'DHCP' option. No further settings are required in that case. After saving the configuration, the controller will try to get an IP address automatically from a DHCP server. If no server is available for a certain period of time, the interface will fall-back to the static IP settings. Click the 'Save Configuration' button, enter the pass-key (*smaract*) in the upcoming dialog window and click 'Ok'.
- To configure a **static IP**, select 'Static IP' and enter the IP address, the gateway IP and the subnet mask in the designated input fields. Click the 'Save Configuration' button, enter the pass-key (*smaract*) and click 'Ok'.
- To **reset** the interface to the factory **default** settings click the 'Reset to Default' button, enter the pass-key (*smaract*) and click 'Ok'.

Note that the timeout for the DHCP client is configurable with the *Network DHCP Timeout* property. Please refer to the *MCS2 Programmers Guide* for more information.



NOTICE

The configuration is saved permanently and the interface will restart with the new configuration! Make sure that the given parameters match your network setup, otherwise the configuration page may become unreachable!

3.2.2 Hand Control Module

The Hand Control Module of the MCS2 may be used to configure the network interface settings. Enter the 'Main Menu' -> 'Settings' -> 'Network Config.' menu and modify the parameters as desired. Select 'Save Config.' to apply the changes.

3.2.3 SmarActNetConfig Tool

The **SmarActNetConfig** tool may be used to find and configure MCS2 devices.

The tool is installed with the MCS2 Software Installer. See the *SmarAct NetConfig User Manual* document for more details on the tool.

3.3 Finding An Unknown IP Address

There are two methods to find an unknown IP address of a MCS2 controller:

1. Use the **SmarActNetConfig** tool
2. Set the MCS2 to default configuration with the 'default config' **push button**

The **SmarActNetConfig** tool is able to find devices regardless of its actual network configuration, even if the parameters do not match the current network settings.

Note that the device cannot be found if the discovering was disabled with the *Network Discover Mode* property. Note further that it cannot be found while the DHCP IP address allocation is running in case the DHCP mode is enabled. If no DHCP server is available the interface will fall-back to the static IP settings after the configured DHCP timeout has expired. After that the device can be found again by the discovering.

For the second method the MCS2 device has a **push button** on the front panel which may be used to reset the interface configuration to the static default configuration temporarily. The button is located behind a small hole below the ethernet connector on the front panel. Use a pen or a paperclip to press the button for minimum 5 seconds. Note that this IP setting is volatile, meaning that a power cycle will restore the original settings assumed they have not been reconfigured in this session.

Now connect to the MCS2 configuration webpage with an internet browser by using the default IP address: 192.168.1.200. Use the configuration tab to configure a new IP address as desired. For this method the MCS2 must be connected to a network in the address range: 192.168.xxx.xxx. The easiest way to do this is to connect the MCS2 directly to the PC ethernet interface and to configure a static IP address for the PC. (For example 192.168.1.100).

4 TECHNICAL DATA

4.1 Status LED

MCS2 controllers without an integrated Hand Control Module are equipped with a status LED. This LED shows the current device state. Usually the LED is permanently on signaling the normal operation. A sensor module attach or detach process is indicated by fading the LED down and up for ca. 1 second. According to the following table different flashing patterns may occur.

Table 4.1 – LED states

LED Pattern	Frequency	Description
On	-	Regular operation
Flashing	2 Hz	Over-temperature of min. one amplifier
Flashing	5 Hz	High-voltage overload
Flashing	10 Hz	High-voltage supply failure
Flashing	15 Hz	The device is in the bootloader state and has no valid application
Fading up and down	1 Hz	The device is in the bootloader state

4.2 MCS2 Main Controller Connectors

4.2.1 Power Supply Connectors

The MCS2 controller is supplied by a 12V power supply. Please use the power supply that has been shipped with the MCS2 controller and make sure it matches the current and power rating, which is specified on the label of the controller (on the bottom or back side of the housing).

3-/6-Channel Controller

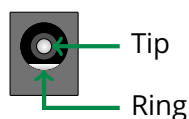

Figure 4.1: DC power connector for power supply

Note that the used barrel power connector must have a pinhole diameter of 2.1mm and an outside diameter of 5.5mm.

Table 4.2 – DC Power Connector Pin Assignment

Pin	Signal	Function
Tip	12V	+12V DC Controller Power Supply
Ring	RTN	Power Supply Return

9-Channel Controller

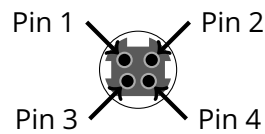

Figure 4.2: Female KPPX connector for power supply

Table 4.3 – KPPX Pin Assignment

Pin	Signal	Function
1, 2	12V	+12V DC Controller Power Supply
3, 4	RTN	Power Supply Return
Shielding	PE	Protective Earth

12-Channel Controller

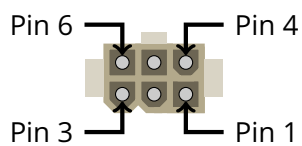

Figure 4.3: Female Mini Fit Jr. connector for power supply

Table 4.4 – Mini Fit Jr. Pin Assignment

Pin	Signal	Function
1, 2, 3	12V	+12V DC Controller Power Supply
4, 5, 6	RTN	Power Supply Return

4.2.2 D-SUB-15 Connector for Sensor Module

The MCS2 controller provides one or more female D-SUB-15 connectors to stick-slip positioners via an MCS2 Sensor Module. The pin layout is described below.

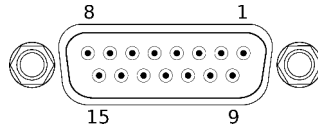

D-SUB-15 connector to Sensor Module

Table 4.5 – DSUB15 Pin Assignment

Pin	Signal	Function
1	HV-OUT-1	Positioner driving signal, channel 1, 4, 7, ... ⚠
2	HV-OUT-2	Positioner driving signal, channel 2, 5, 8, ... ⚠
3	HV-OUT-3	Positioner driving signal, channel 3, 6, 9, ... ⚠
4	SM-GND	Ground for Sensor Module and sensor
5	SM-TX-D-	RS-422 D- signal from Sensor Module
6	SM-RX-D-	RS-422 D- signal to Sensor Module
7	d.n.c.	DO NOT CONNECT
8	EXT_STATE	Internal signal lines
9	HV-GND-1	Ground for positioner driving signal, channel 1, 4, 7, ...
10	HV-GND-2	Ground for positioner driving signal, channel 2, 5, 8, ...
11	HV-GND-3	Ground for positioner driving signal, channel 3, 6, 9, ...
12	SM-TX-D+	RS-422 D+ signal from Sensor Module
13	SM-RX-D+	RS-422 D+ signal to Sensor Module
14	SyncB	Internal sync line
15	SM-5V	Power supply for Sensor Module, 5V DC
Shielding	SM-Shield	Shielding for Sensor Module and sensor

4.2.3 D-SUB-15-HD Connector for External Hand Control Module

For external Hand Control Modules the MCS2 controller provides a female D-SUB-15 high-density connector. The pin layout is described below.

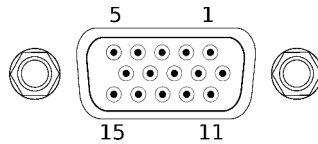

D-SUB-15-HD connector to external Hand Control Module

Table 4.6 – Pin Assignment

Pin	Signal	Function
1	GND	Ground
2	d.n.c.	DO NOT CONNECT
3	d.n.c.	DO NOT CONNECT
4	d.n.c.	DO NOT CONNECT
5	d.n.c.	DO NOT CONNECT
6	3.3V	Power supply, 3.3V DC
7	d.n.c.	DO NOT CONNECT
8	GND	Ground
9	SyncB	Internal sync line
10	5V	Power supply, 5V DC
11	Switch	Power switch
12	RXD+	Differential data for receiving
13	RXD-	Differential data for receiving
14	TXD+	Differential data for transmitting
15	TXD-	Differential data for transmitting
Shielding	GND	Ground

4.2.4 USB Connector

The USB Type B connector offers direct connectivity e.g. to a PC for software control of the MCS2. The USB interface is galvanically isolated to the internal ground of the controller.

4.2.5 RJ-45 Connector for Ethernet Communication

The RJ-45 connector at the MCS2 main controller provides a standard 10BaseT / 100BaseTX ethernet interface for software control of the MCS2.

4.2.6 BNC Connectors for Fast Digital Input/Outputs

The BNC connectors provide fast digital outputs (DO1, DO2, DO3) and digital device inputs (DI1). The connectors are galvanically isolated to the internal ground of the controller.

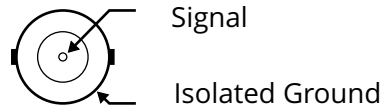

BNC connector

4.2.7 D-SUB-37 Connector of Auxiliary I/O

The D-Sub-37 female connector provides analog and digital auxiliary inputs and outputs. All signals are galvanically isolated to the internal ground of the controller.

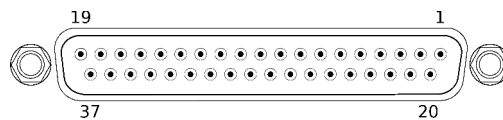

D-SUB-37 connector of Auxiliary I/O

Table 4.7 – Pin Assignment

Pin	Signal	Function
25	DIN-1	Digital Device Trigger Input
24	GNDiso	Corresponding GNDiso for DIN-1
21	GP-DIN-1	General Purpose Digital Input 1
22	GP-DIN-2	General Purpose Digital Input 2
23	GP-DIN-3	General Purpose Digital Input 3
6	GP-DIN-4	General Purpose Digital Input 4
20	GNDiso	Corresponding GNDiso for GP-DIN-1/-2/-3/-4
7	GP-DOUT-1	General Purpose Digital Output 1, Open Collector
8	GP-DOUT-2	General Purpose Digital Output 2, Open Collector
27	GP-DOUT-3	General Purpose Digital Output 3, Open Collector
9	GP-DOUT-4	General Purpose Digital Output 4, Open Collector
26	GNDiso	Corresponding GNDiso for GP-DOUT-1/-2/-3/-4

Continued on next page

Table 4.7 – Continued from previous page

Pin	Signal	Function
10	DOUT-1	Fast Digital Output 1
29	DOUT-2	Fast Digital Output 2
11	DOUT-3	Fast Digital Output 3
28	GNDiso	Corresponding GNDiso for DOUT-1/-2/-3
12	AIN-6	Fast Analog Input 6
30	GNDiso	Corresponding GNDiso for AIN-6
13	AIN-5	Fast Analog Input 5
31	GNDiso	Corresponding GNDiso for AIN-5
14	AIN-4	Fast Analog Input 4
32	GNDiso	Corresponding GNDiso for AIN-4
15	AIN-3	Fast Analog Input 3
33	GNDiso	Corresponding GNDiso for AIN-3
16	AIN-2	Fast Analog Input 2
34	GNDiso	Corresponding GNDiso for AIN-2
17	AIN-1	Fast Analog Input 1
35	GNDiso	Corresponding GNDiso for AIN-1
18	AOUT-2	General Purpose Analog Output 2
36	GNDiso	Corresponding GNDiso for AOUT-2
19	AOUT-1	General Purpose Analog Output 1
37	GNDiso	Corresponding GNDiso for AOUT-1
1	d.n.c	DO NOT CONNECT, Internally Used
2-5	NC	Not Connected
Shielding	GND	Ground

4.3 MCS2 Sensor Module Connectors

4.3.1 D-SUB-15 Positioner Connectors

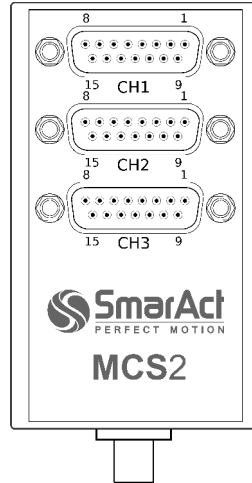

Sensor Module D-SUB-15 connectors

Table 4.8 – Pin Assignment

Pin	Signal	Function
1	HV-OUT-x	Positioner driving signal, channel x
2	d.n.c.	DO NOT CONNECT
3	d.n.c.	DO NOT CONNECT
4	S-GND	Ground for sensor
5	S-SIN+	sin+ signal from sensor
6	S-COS+	cos+ signal from sensor
7	S-REF+	ref+ signal from sensor
8	d.n.c.	DO NOT CONNECT
9	HV-GND-x	Ground for positioner driving signal, channel x
10	d.n.c.	DO NOT CONNECT
11	d.n.c.	DO NOT CONNECT
12	S-SIN-	sin- signal from sensor
13	S-COS-	cos- signal from sensor
14	S-REF-	ref- signal from sensor
15	S-VCC	Power supply for sensor

*The HV-OUT-x signals are identical to the HV-OUT-x signals from the MCS2 controller.

4.4 MCS2 Electrical Specifications

4.4.1 Positioner Driver Output

Table 4.9 – Driver Output Specification

Parameter	Value	Unit
<i>Driving Signal (HV-OUT-x)</i>		
Signalform	sawtooth (step mode) constant (scan mode)	
Output voltage range	0 to 100	V
Average current per channel	200	mA
Peak current per channel, < 10 μ s, max. speed	20	A

4.4.2 Auxiliary Fast Digital Input/Outputs

All signals are galvanically isolated to the internal ground of the controller. The **digital device input** has schmitt-trigger characteristics. Table 4.10 lists the threshold voltage levels. The output voltage level of the **fast digital outputs** can be configured to 3.3V or 5V by software. This setting is global for all digital outputs. Note that the digital outputs are in a high-impedance state by default, therefore the output driver must be explicitly enabled.

Table 4.10 – Fast Digital Input/Output Specification

Parameter	Condition	Vcc	MIN	TYP	MAX	Unit
<i>Common</i>						
V_{iso}					60	V
R_{iso}				10		M Ω
<i>Digital Device Inputs</i>						
V_i			-0.3		5.5	V
V_{ih}		3.3V/5V		1.9	2.1	V
V_{il}		3.3V/5V	1.0	1.2		V
R_i				1		M Ω
<i>Fast Digital Outputs</i>						
I_o		3.3V			8	mA
I_o		5V			3	mA

Continued on next page

Table 4.10 – Continued from previous page

Parameter	Condition	Vcc	MIN	TYP	MAX	Unit
V _{oh}	I _{oh} = 20uA	3.3V/5V	V _{cc} -0.1			V
V _{oh}	I _{oh} = 2mA	3.3V	3.05			V
V _{oh}	I _{oh} = 3mA	3.3V	2.90			V
V _{oh}	I _{oh} = 5.5mA	3.3V	2.60			V
V _{oh}	I _{oh} = 8mA	3.3V	2.50			V
V _{oh}	I _{oh} = 2mA	5V	4.75			V
V _{oh}	I _{oh} = 3mA	5V	4.60			V
V _{oh}	I _{oh} = 5.5mA	5V	4.30			V
V _{oh}	I _{oh} = 8mA	5V	4.20			V
V _{ol}	I _{ol} = -20uA	3.3V/5V			0.10	V
V _{ol}	I _{ol} = -2mA	3.3V			0.20	V
V _{ol}	I _{ol} = -3mA	3.3V			0.26	V
V _{ol}	I _{ol} = -5.5mA	3.3V			0.49	V
V _{ol}	I _{ol} = -8mA	3.3V			0.71	V
V _{ol}	I _{ol} = -2mA	5V			0.20	V
V _{ol}	I _{ol} = -3mA	5V			0.25	V
V _{ol}	I _{ol} = -5.5mA	5V			0.48	V
V _{ol}	I _{ol} = -8mA	5V			0.70	V

4.4.3 Auxiliary GP Digital Inputs/Outputs

All signals are galvanically isolated to the internal ground of the controller. The **general purpose digital inputs** have schmitt-trigger characteristics. Table 4.11 lists the threshold voltage levels. The **general purpose digital outputs** are designed as open-collector outputs. This means that the output logic is inverted. Writing a one to an output switches the output transistor on which leads to a low signal level at the output pin.

Table 4.11 – General Purpose Digital Inputs/Outputs Specification

Parameter	Condition	Vcc	MIN	TYP	MAX	Unit
<i>Common</i>						
V _{iso}					60	V
R _{iso}				10		MΩ
<i>General Purpose Digital Inputs</i>						

Continued on next page

Table 4.11 – Continued from previous page

Parameter	Condition	Vcc	MIN	TYP	MAX	Unit
V _i			-0.3		5.5	V
V _{ih}		3.3V/5V		1.9	2.1	V
V _{il}		3.3V/5V	1.0	1.2		V
R _i				1		MΩ
<i>General Purpose Digital Outputs</i>						
I _{ol}	Open Collector				700	mA
I _{oh}	Open Collector			2		μA
V _{oh}	Open Collector				24	V
R _{on}	Open Collector			400		mΩ

4.4.4 Auxiliary GP Analog Outputs

The **analog outputs** feature a DAC with 16bit resolution. All outputs are galvanically isolated to the internal ground of the controller. The corresponding GND signals of the specific outputs should be used to archive the best performance.



NOTICE

Note that the analog outputs may generate a short random voltage peak in the range of $\pm 10V$ while powering up or down the controller before the level stabilizes at its default level of 0V. External equipment must be capable of standing this or must be disconnected while power-up / power-down.

Table 4.12 – General Purpose Analog Outputs Specification

Parameter	Condition	MIN	TYP	MAX	Unit
<i>Common</i>					
V _{iso}				60	V
R _{iso}			10		MΩ
<i>General Purpose Analog Outputs</i>					
V _o		-10		10	V
I _o				10	mA
R _o			10		Ω
INL	Using line passing through codes 512 and 65024		±4		LSB
DNL			±0.2		LSB

Continued on next page

Table 4.12 – Continued from previous page

Parameter	Condition	MIN	TYP	MAX	Unit
V _{offset}			±4		mV
V _{noise}			860		μV _{pp}
t _{settling}			290		μs
Slew rate	measured btw. 10 to 90 % of a full-scale transition		0.163		V/μs
DC crosstalk	channel to channel		60		μV

4.4.5 Auxiliary Fast Analog Inputs

The **fast analog inputs** feature an ADC with 16bit resolution and a build-in 2nd-order low pass filter. All inputs are galvanically isolated to the internal ground of the controller. The corresponding GND signals of the specific inputs should be used to archive the best performance. The input range of the analog inputs is configurable for unipolar as well as bipolar operation. Note that this setting is global for all analog inputs. The total number of six analog inputs are mapped in groups of two to the channels of the corresponding driver module.

Table 4.13 – Fast Analog Inputs Specification

Parameter	Condition	MIN	TYP	MAX	Unit
<i>Common</i>					
V _{iso}				60	V
R _{iso}			10		MΩ
<i>Fast Analog Inputs</i>					
V _{ovp}		-11		11	V
R _i			500		kΩ
F _{co}	-3dB		15		kHz
F _{sample}	per channel		50		kHz
INL			±1	2	LSB
DNL			±0.5	1.5	LSB
SINAD			91.5		dB
E _{gain}			0.1		% FSR
E _{offset}			±0.5		mV
V _i	input range=5.12V	0		5.12	V
V _i	input range=10.24V	0		10.24	V
V _i	input range=±2.56V	-2.56		2.56	V

Continued on next page

Table 4.13 – Continued from previous page

Parameter	Condition	MIN	TYP	MAX	Unit
V _i	input range=±5.12V	-5.12		5.12	V
V _i	input range=±10.24V	-10.24		10.24	V

4.4.6 Abbreviations

- V_{iso} : allowed voltage difference from isolated ground to internal ground
- R_{iso} : isolation resistance from isolated ground to internal ground
- V_{cc} : configured common supply voltage
- V_{oh} : minimal output value if output is set high
- V_{ol} : maximal output value if output is set low
- V_o : output voltage range
- I_o : allowed output current
- I_{oh} : output current during high state (source current)
- I_{ol} : output current during low state (sink current)
- V_i : allowed input voltage
- V_{ovp} : overvoltage protection voltage
- V_{ih} : input voltage that is interpreted as high level
- V_{il} : input voltage that is interpreted as low level
- R_i : input impedance value
- R_o : output impedance value
- F_{co} : input filter cut-off frequency
- INL: integral nonlinearity
- DNL: differential nonlinearity
- SINAD: signal-to-noise ratio
- E_{gain} : gain error
- E_{offset} : offset error in % full-scale-range (FSR)
- V_{offset} : offset error
- V_{noise} : DAC output noise
- $t_{settling}$: output voltage settling time (transition time between 1/4 scale and 3/4 scale, including settling to $\pm 0.024\%$ within FSR)

Sales partner / Contacts

Headquarters

SmarAct GmbH

Schuetten-Lanz-Strasse 9
26135 Oldenburg
Germany

T: +49 441 – 800 87 90
Email: info-de@smaract.com
www.smaract.com

France

SmarAct GmbH

Schuetten-Lanz-Strasse 9
26135 Oldenburg
Germany

T: +49 441 – 80 08 79 956
Email: info-fr@smaract.com
www.smaract.com

Israel

Trico Israel Ltd.

P.O.Box 6172
46150 Herzeliya
Israel

T: +972 9 – 950 60 74
Email: info-il@smaract.com
www.trico.co.il

Japan

Physix Technology Inc.

Ichikawa-Business-Plaza
4-2-5 Minami-yawata,
Ichikawa-shi
272-0023 Chiba
Japan

T/F: +81 47 – 370 86 00
Email: info-jp@smaract.com
www.physix-tech.com

South Korea

SEUM Tronics

801, 1, Gasan digital 1-ro
Geumcheon-gu
Seoul, 08594,
Korea

T: +82 2 868 – 10 02
Email: info-kr@smaract.com
www.seumtronics.com

USA

SmarAct Inc.

2140 Shattuck Ave. Suite 1103
Berkeley, CA 94704
United States of America

T: +1 415 – 766 9006
Email: info-us@smaract.com
www.smaract.com